

对本手册所包含的内容，荣伟电气有限公司拥有最终解释权，更多详细资料敬请垂询，本公司工程技术人员将竭诚为您服务；  
因产品技术不断创新，请以实物或说明书为准；如有变更，届时恕不另行通知。

Rongwei Electric Co., Ltd. has the right of final interpretation of the contents contained in this manual.

More details please contact us, the company's engineering and technical staff will be happy to serve you;

Due to the continuous innovation of product technology, please refer to the physical or manual; Subject to change without prior notice.

**R&R** RONGWEI  
ELECTRIC  
荣伟电气

**R&R**

荣伟电气有限公司  
RONGWEI ELECTRIC CO., LTD

地址: 浙江·温州市·海经区昆鹏街道雁云路176号15-4  
ADD: 15-4 No.176, Yan Yun Avenue, MarineEconomic District,  
Wenzhou, Zhejiang, China  
TEL: +86-577-6167 8000 / 62770777  
FAX: +86-577-6167 8080  
URL: <http://www.chinarongwei.com>  
E-mail: [rongwei@chinarongwei.com](mailto:rongwei@chinarongwei.com)



**PRODUCTS  
CATALOG**  
2025 Version

**防水系列**  
WATERPROOF

# 01

Connect to source  
Bless the world

## 公司简介

# COMPANY PROFILE

Rongwei Electric  
Co., LTD



ISO9001 认证 标志 CE TÜV IP68 RoHS REACH

连接源头 祝福世界

# 20+

## 配线器材生产经验

Wiring accessories production  
experience

荣伟电气有限公司位于浙江省温州市海经区机器人产业园，是一家集生产、研发、销售于一体的现代化企业，专业从事配线器材的生产已逾20年。

公司以“专业专注，高端有效，诚心挚诚”为经营理念，致力于探索新科技，研发新产品，以完善的管理，高端的品质将自身打造成为国内外知名品牌。着眼于未来，与时俱进。

Rongwei Electric Co.,Ltd.(R&R) is located in robot industrial zone, Marine Economic District, Wenzhou City, Zhejiang Province. Who is a modernized enterprise with over 20 years of experience in producing connectors.

R&R's philosophy is to "focusing on professionalization, efficiency, high-end products, and sincerity". R&R has already spent many years on its long-term goal which is to "explore new technologies, develop new products". Per our successful experience and products, R&R has become a well-know brand in the world.

# 30+

## 高级技术人员

Senior technical staff

为此公司投入巨资更新生产设备，实现注塑生产中央统一管理，升级产品自动化装配系统。同时也十分注重实验室的建设，目前公司可独立完成对接连接器产品的防水、阻燃、高低温环境、耐腐蚀、抗冲击等多种性能指标的检测。

本公司通过了ISO9001国际质量管理体系的认证，并陆续获得了UL、TUV、ATEX、UKCA、CE、IP68、RoHS、REACH等产品认证和测试。

我公司生产的连接器产品广泛应用于通讯设备、配电设备、配电设施、仪器仪表、医疗器械等众多领域，不仅在国内占有相当的市场份额，产品还远销西欧，北美，日本，韩国等国家和地区，并成为如MOLEX、AMPHENOL、SAMSUNG等诸多知名公司的指定供应商。

荣伟电气愿成为您迈向成功之路的合作伙伴，期待与您一起携手“连接源头，祝福世界”！

Advancing with the times, the company has invested heavily in updating production equipment, realizing central management of injection plant, building full automatic parts assembling line etc. The company has also put great emphasis on the construction of test lab, the Lab is able to finish performance checking by themselves for Waterproof, Flame Resistance, High-low Temp., Anti-corrosion, Impact resistance etc.

We are certified by ISO9001, and our products approved by UL, TUV, ATEX, UKCA, CE, IP68 RoHS and REACH successively.

The connectors we produced are widely applied to Communication equipment, Power facilities, Instrument & Apparatus and Medical appliance, the products is not just having very good market share of domestic sales, but also exported to Western Europe, North America, Japan and Korea, and became the appointed vendor of famous brand companies, such as Molex, Amphenol and Samsung etc.

R&R is willing to be the partner on your way towards success, looking forward to "Connect to source, bless the world" together with you !



ISO9001 认证 证书 CE TUV IP68 RoHS REACH

**R&R**

**50+** 台

产品专业生产设备

Professional production equipment



▲ 仓库 Warehouse



▲ 注塑车间 Injection workshop



▲ 自动装配车间 Automatic assembly workshop

**02**

Connect to source  
Bless the world

**生产车间**  
**PRODUCTION**  
**WORKSHOP**

Rongwei Electric  
Co., LTD

荣伟电气有限公司

凭借先进的生产设备和检测手段

融入现代化企业的生产经营理念

以先进的产品

卓越的服务

合理的价格

为客户创造价值

Rongwei Electric Co.,Ltd.

With advanced production equipment and

testing method,

Integrate into the production and

management concept of modern enterprise

with advanced products,

Excellent service,

Reasonable price,

R&R creates the benefit for customers.

**20+** 台

产品专业检测设备

Professional testing equipment

# 03

Connect to source  
Bless the world

## 资质证书

# QUALIFICATION CERTIFICATE

Rongwei Electric  
Co., LTD

ISO9001 UK CE TUV IP68 RoHS REACH

# R&R

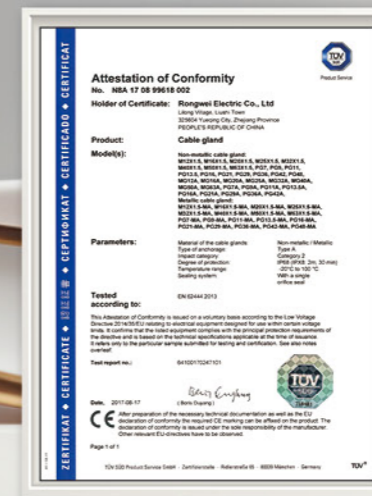
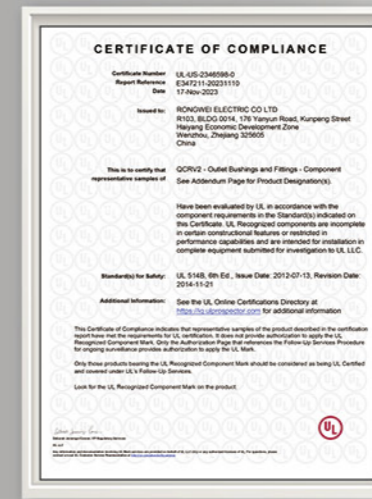

# 10+

## 产品专业国际认证

More than 10 international  
certifications

## Waterproof Box Series

防水盒系列

# A



- 01 RB-AG 开关防水盒      Junction box
- 03 不锈钢搭扣防水盒      Stainless steel buckle waterproof box
- 05 RB-PCG 防水箱      waterproof box

## Metal Waterproof Enclosure Series

金属防水箱系列

# B



- 07 RBT 挂墙式金属防水箱      Wall Mounting Metal Waterproof Enclosure
- 09 RBB 不锈钢防水箱      Stainless steel Waterproof Enclosure

## waterproof aviation connector series

防水航空插系列

# C



- 11 防水航空插 / 解析图      waterproof aviation connector/analytical diagram
- 13 SP11 防水航空插      waterproof aviation connector
- 15 SP13 防水航空插      waterproof aviation connector
- 17 SP17 防水航空插      waterproof aviation connector
- 19 SP21 防水航空插      waterproof aviation connector
- 21 SP29 防水航空插      waterproof aviation connector

## Quick wire connector series

快速连接器系列

# D



- 23 221 系列      series
- 24 222 系列      series
- 25 222-22MINI 系列      series
- 26 222-2 系列      series
- 27 222-22 系列      series
- 28 分线系列      Branch series
- 31 2604 系列      series
- 32 2604D 系列      series
- 33 773-10 系列      series
- 34 773-20-30 系列      series
- 35 012 系列      series
- 36 照明器具用连接器系列      Connector series for lighting appliances
- 37 导轨型系列      Guideway series
- 38 免破线系列      No break line series

# RB-AG开关防水盒 Junction box



防水盒 Waterproof box

单位Unit: mm



- 材质: ABS/PC
- 防护等级: IP66
- 特性: 轻便, 耐腐蚀, 绝缘性佳
- 适用于: 机场, 地铁站, 按钮盒, 小型终端机, 信号机箱, 继电器, 传感器, 通信接线盒等设备

- Material: ABS/PC
- Protection degree: IP66
- Product Feature: portable, corrosion resisting, excellent insulation
- Application: It can be applied to pushbutton box, terminal box, signal box, relays box, sensor box and communication junction box and so on in airport, subway stooion



型号 Model number				尺寸 dimension(高H×宽W×深D)
灰色盖子 ABS Grey lid	透明盖子 ABS/PC Transparent lid	灰色盖子 PC Grey lid	透明盖子 PC Transparent lid	
RB-AG-655055	RB-AT-655055	RB-PG-655055	RB-PT-655055	65×50×55
RB-AG-956555	RB-AT-956555	RB-PG-956555	RB-PT-956555	95×65×55
RB-AG-118045	RB-AT-118045	RB-PG-118045	RB-PT-118045	110×80×45
RB-AG-118070	RB-AT-118070	RB-PG-118070	RB-PT-118070	110×80×70
RB-AG-118085	RB-AT-118085	RB-PG-118085	RB-PT-118085	110×80×85
RB-AG-138070	RB-AT-138070	RB-PG-138070	RB-PT-138070	130×80×70
RB-AG-138085	RB-AT-138085	RB-PG-138085	RB-PT-138085	130×80×85
RB-AG-168055	RB-AT-168055	RB-PG-168055	RB-PT-168055	160×80×55
RB-AG-188065	RB-AT-188065	RB-PG-188065	RB-PT-188065	180×80×65
RB-AG-258065	RB-AT-258065	RB-PG-258065	RB-PT-258065	250×80×65
RB-AG-258085	RB-AT-258085	RB-PG-258085	RB-PT-258085	250×80×85
RB-AG-101075	RB-AT-101075	RB-PG-101075	RB-PT-101075	100×100×75
RB-AG-121275	RB-AT-121275	RB-PG-121275	RB-PT-121275	125×125×75
RB-AG-121210	RB-AT-121210	RB-PG-121210	RB-PT-121210	125×125×100
RB-AG-171275	RB-AT-171275	RB-PG-171275	RB-PT-171275	175×125×75
RB-AG-171210	RB-AT-171210	RB-PG-171210	RB-PT-171210	175×125×100
RB-AG-171495	RB-AT-171495	RB-PG-171495	RB-PT-171495	170×140×95
RB-AG-171710	RB-AT-171710	RB-PG-171710	RB-PT-171710	175×175×100
RB-AG-201510	RB-AT-201510	RB-PG-201510	RB-PT-201510	200×150×100
RB-AG-201513	RB-AT-201513	RB-PG-201513	RB-PT-201513	200×150×130
RB-AG-251510	RB-AT-251510	RB-PG-251510	RB-PT-251510	250×150×100
RB-AG-251513	RB-AT-251513	RB-PG-251513	RB-PT-251513	250×150×130
RB-AG-251775	RB-AT-251775	RB-PG-251775	RB-PT-251775	250×175×75
RB-AG-251710	RB-AT-251710	RB-PG-251710	RB-PT-251710	250×175×100
RB-AG-202095	RB-AT-202095	RB-PG-202095	RB-PT-202095	200×200×95
RB-AG-202013	RB-AT-202013	RB-PG-202013	RB-PT-202013	200×200×130
RB-AG-192813	RB-AT-192813	RB-PG-192813	RB-PT-192813	190×280×130
RB-AG-282813	RB-AT-282813	RB-PG-282813	RB-PT-282813	280×280×130
RB-AG-193813	RB-AT-193813	RB-PG-193813	RB-PT-193813	190×380×130



# 不锈钢搭扣防水盒 Stainless steel buckle waterproof box



03/04

防水盒 Waterproof box

单位Unit: mm



- 材质: ABS/PC
- 防护等级: IP66
- 特性: 轻便, 耐腐蚀, 绝缘性佳
- 适用于: 机场, 地铁站, 按钮盒, 小型终端机, 信号机箱, 继电器, 传感器, 通信接线盒等设备

- **Material:** ABS/PC
- **Protection degree:** IP66
- **Product Feature:** portable, corrosion resisting, excellent insulation
- **Application:** It can be applied to pushbutton box, terminal box, signal box, relays box, sensor box and communication junction box and so on in airport, subway station



搭扣NPG/T系列	PC灰盖	PC透明盖
150×100×90	RB-NPG-151090	RB-NPT-151090
175×125×90	RB-NPG-171290	RB-NPT-171290
150×150×90	RB-NPG-151590	RB-NPT-151590
210×160×100	RB-NPG-211610	RB-NPT-211610
210×210×130	RB-NPG-212113	RB-NPT-212113
275×175×110	RB-NPG-271713	RB-NPT-271713
280×190×140	RB-NPG-281914	RB-NPT-281914
300×200×130	RB-NPG-302013	RB-NPT-302013
300×200×170	RB-NPG-302017	RB-NPT-302017
300×300×150	RB-NPG-303015	RB-NPT-303015
380×280×140	RB-NPG-382814	RB-NPT-382814
350×250×150	RB-NPG-352515	RB-NPT-352515
400×300×170	RB-NPG-403017	RB-NPT-403017
430×330×180	RB-NPG-433318	RB-NPT-433318
530×430×200	RB-NPG-534320	RB-NPT-534320
630×430×230	RB-NPG-634323	RB-NPT-634323
600×500×220	RB-NPG-605022	RB-NPT-605022
730×530×250	RB-NPG-735325	RB-NPT-735325
830×630×280	RB-NPG-836328	RB-NPT-836328



防水盒 Waterproof box



- 材质: 高强度PC
- 防护等级: IP66
- 抗冲击力: IK08
- 适用于: T端子箱, 配电板, 仪器仪表盒, 信号箱等设备。

- **Material:** High strength PC
- **Protection degree:** IP66
- **Impact resistance:** IK08
- **Applicable to:** T terminal box, switchboard, Instrument box, signal box and other equipment.



### PC 料灰盖 PC GRAY COVER

单位Unit: mm

型号 Model number	尺寸 dimension(高H×宽W×深D)	备注 remark
RB-PCG-203017	200×300×170	二个搭扣two buckless
RB-PCG-304017	300×400×170	
RB-PCG-405020	400×500×200	三个搭扣three buckless
RB-PCG-406022	400×600×220	

### PC 料透明盖 PC TRANSPRENT COVER

单位Unit: mm

型号 Model number	尺寸 dimension(高H×宽W×深D)	备注 remark
RB-PCT-203017	200×300×170	二个搭扣two buckless
RB-PCT-304017	300×400×170	
RB-PCT-405020	400×500×200	三个搭扣three buckless
RB-PCT-406022	400×600×220	

### 金属底板 / 塑料底板 GALVANIZED BASEPLATE/PLASTIC

配件 ACCESSORY

型号 Model number	尺寸 dimension(高H×宽W×深D)	备注 remark
RB-302017	169x273X2	金属板/塑料板 Metal plate/plastic plate
RB-403017	269x372X2	
RB-504020	368x472X2	
RB-604022	368x572X2	

### 镀锌中间门板 GALVANIZED MIDDLE DOOR

配件 ACCESSORY

型号 Model number	尺寸 dimension(高H×宽W×深D)	备注 remark
RB-302017	171x271X2	金属板/塑料板 Metal plate/plastic plate
RB-403017	271x371X2	
RB-504020	371x471X2	
RB-604022	371x571X2	





# RBT挂墙式金属防水箱 Wall Mounting Metal Waterproof Enclosure



07/08

金属防水箱 Metal Waterproof Enclosure

单位Unit: mm



- 材质: 冷轧钢板, 喷漆/镀锌底板
  - 表面处理: 热固粉末涂层, 波纹饰板
  - 防护等级: IP66
  - 抗冲击力: IK10
  - 颜色: RAL7032/RAL7035
  - 温度范围: -40°C- 80°C
- **Material:** cold-rolled steel,painted/galvanized sheet
  - **Surface treatment:** thermosetting power coating,corrugate finish
  - **Protection degree:** IP66
  - **Impact resistance:** IK10
  - **Color:** RAL7032/RAL7035
  - **Temperature range:** -40°C- 80°C

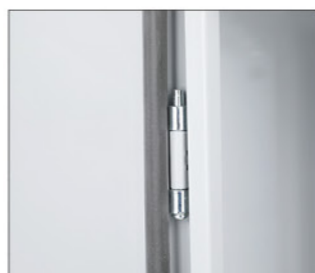
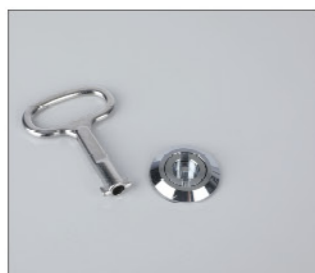

型号 Model number	尺寸 dimension(高H×宽W×深D)	型号 Model number	尺寸 dimension(高H×宽W×深D)
RBT202015	200×200×150	RBT604015	600×400×150
RBT252015	250×200×150	RBT604020	600×400×200
RBT302015	300×200×150	RBT604025	600×400×250
RBT302020	300×200×200	RBT604030	600×400×300
RBT302520	300×250×200	RBT605015	600×500×150
RBT303015	300×300×150	RBT605020	600×500×200
RBT303020	300×300×200	RBT605025	600×500×250
RBT303025	300×300×250	RBT605030	600×500×300
RBT403015	400×300×150	RBT606015	600×600×150
RBT403020	400×300×200	RBT606020	600×600×200
RBT403025	400×300×250	RBT606025	600×600×250
RBT404015	400×400×150	RBT704020	700×400×200
RBT404020	400×400×200	RBT704030	700×400×300
RBT404025	400×400×250	RBT705015	700×500×150
RBT503015	500×300×150	RBT705020	700×500×200
RBT503020	500×300×200	RBT705025	700×500×250
RBT503030	500×300×300	RBT706020	700×600×200
RBT504015	500×400×150	RBT706025	700×600×250
RBT504020	500×400×200	RBT806020	800×600×200
RBT504025	500×400×250	RBT806025	800×600×250
RBT504030	500×400×300	RBT806030	800×600×300
RBT505015	500×500×150	RBT808020	800×800×200
RBT505020	500×500×200	RBT808025	800×800×250
RBT505025	500×500×250	RBT808030	800×800×300

## 产品特点

PU发泡密封条确保箱体达到IP66的防护等级  
各种类型及尺寸的凸台确保进出线方便  
镀锌安装板也可在箱体外做布线用  
箱口多层保护槽不但起加固作用而且能  
防止门板打开时脏物和水进入箱内带双齿锁芯的专业锁系统  
开和关都极为便捷

可定制非标产品  
Nonstandard products are customizable

## Features of products

PU foaming sealing strip ensures a protection grade of IP66 to box  
Bosses of various types and sizes allow easy installation of inlet/outlet lines  
Galvanized mounting plate can also be used for wiring outside the box  
Multiple protection grooves are designed at the box opening can not only reinforce the structure but also prevent the entry of dirt or water when the door is opened Professional lock system with double-teeth cylinder allows easy locking/unlocking



# RBB不锈钢防水箱 Stainless steel Waterproof Enclosure



09/10

金属防水箱 Metal Waterproof Enclosure

单位Unit: mm



型号 Model number	尺寸 dimension(高H×宽W×深D)	型号 Model number	尺寸 dimension(高H×宽W×深D)
RBB202015	200×200×150	RBB505025	500×500×250
RBB302015	300×200×150	RBB604020	600×400×200
RBB302520	300×250×200	RBB604025	600×400×250
RBB403015	400×300×150	RBB605020	600×500×200
RBB403020	400×300×200	RBB605025	600×500×250
RBB403025	400×300×250	RBB605030	600×500×300
RBB404015	400×400×150	RBB705020	700×500×200
RBB404025	400×400×250	RBB705025	700×500×250
RBB504020	500×400×200	RBB806020	800×600×200
RBB504025	500×400×250	RBB806025	800×600×250
RBB505020	500×500×200	RBB806030	800×600×300

- 材质: SUS304(其他材料可选)
- 表面处理: 拉丝处理
- 防护等级: IP66
- 抗冲击力: IK10
- 温度范围: -40°C- 80°C
- Material: SUS304(other material are optional)
- Surface treatment: wiredrawing
- Protection degree: IP66
- Impact resistance: IK10
- Temperature range: -40°C to 80°C

## 产品特点

PU发泡密封条确保箱体达到IP66的防护等级  
各种类型及尺寸的凸台确保进出线方便  
镀锌安装板也可在箱体外做布线用  
箱口多层保护槽不但起加固作用而且能防止门板打开时脏物和水进入箱内带双齿锁芯的专业锁系统开和关都极为便捷

可定制非标产品  
Nonstandard products are customizable

## Features of products

PU foaming sealing strip ensures a protection grade of IP66 to box  
Bosses of various types and sizes allow easy installation of inlet/outlet lines  
Galvanized mounting plate can also be used for wiring outside the box  
Multiple protection grooves are designed at the box opening can not only reinforce the structure but also prevent the entry of dirt or water when the door is opened Professional lock system with double-teeth cylinder allows easy locking/unlocking



防水航空插 waterproof aviation connector



### 产品概述 Product overview

防水航空插系列凭借丰富的多样性选择，为电气连接需求提供了全面解决方案，涵盖标准电缆插头、弯式电缆插头、对接插座、后螺母插座、两孔法兰插座及方形法兰插座等型号。这些连接器通过同系列芯数匹配与创新的锁紧机制，确保了精准稳固且耐用的电气连接，特别适应高湿度、尘土或振动等恶劣环境，有效防水，保障电气系统安全稳定运行，适配于不同电气应用场景。

With a wide variety of options, the waterproof aviation plug series provides a comprehensive solution for electrical connection needs, including standard cable plugs, bent cable plugs, butt sockets, rear nut sockets, two-hole flange sockets and square flange sockets. Through the same series of core number matching and innovative locking mechanism, these connectors ensure accurate, stable and durable electrical connections, especially suitable for harsh environments such as high humidity, dust or vibration, effective waterproof, ensure the safe and stable operation of electrical systems, and adapt to different electrical application scenarios.

### 材料和技术参数 Material and technical parameters

接插方式 Connection mode	螺纹锁紧 Thread locking	
外壳材料 Housing material	热塑性塑料 Thermoplastic PC, PA66 防火等级 Fire rating: V-0	
绝缘体 Insulator	热塑性塑料 Thermoplastic PPS, 耐高温 High temperature resistance 260°C	
接触件材料 Contact material	铜镀金 Brass with gold-plated	
接线方式 Wiring mode	焊接 Welding: SP13、SP17、SP21、SP29 压接 Crimping: SP17、SP21、SP29 螺丝压接 Screw crimping: SP21、SP29(Φ2.5、Φ3、Φ3.5mm 插针 Pin)	
电缆直径 Cable diameter	SP11: 4-6.5 SP13 I: 4-6.5mm (不标 No mark), II: 5-8mm SP17: 6-10mm	SP21 I: 4.5-7mm, II: 7-12mm (不标 No mark) SP29: 13-16mm
防护等级 Protection grade	IP68	
接插次数 Plugging times	500	
温度范围 Temperature range	-40°C~+85°C	
绝缘电阻 Insulation resistance	2000MΩ	



# SP11防水航空插系列 waterproof aviation socket series



防水航空插 waterproof aviation connector



电缆插头与SP1111  
SP1112、SP1113相配  
Cable plug match with  
SP1111、SP1112、SP1113

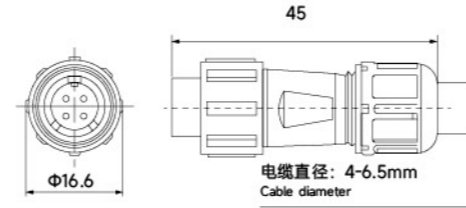

SP1110/ P      SP1110/ S

插针 Pin      芯数 Number of cores  
插孔 Socket



后螺母插座 SP1110相配  
Rear nut socket  
match with SP1110

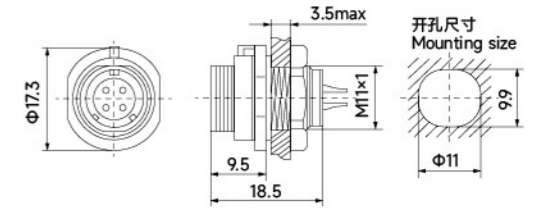

SP1112/P      SP1112/S



电缆对接插座与  
SP1110相配  
Cable butt socket  
match with SP1110

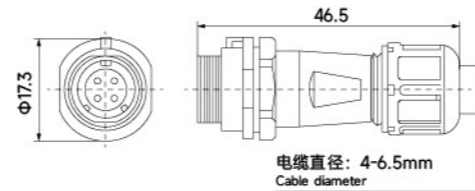

SP1111/P      SP1111/S



法兰插座与SP1110相配  
Flange socket  
match with SP1110

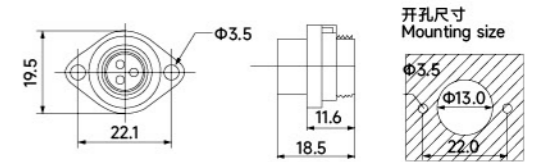

SP1113/P      SP1113/S

## 焊接芯件参数表 Welding core parameters table

芯数 Number of cores	2	3
公端绝缘体正面图 Front view of male insulator		
额定电流 Rated current(A)	5	5
接触件直径 Contact diameter(mm)	Φ1×2	Φ1×3
工作电压 Operating voltage(AC.V)	180	180
耐压 Withstand voltage(AC.V)1min	1000	1000
接触电阻 Contact resistance(mΩ)	5	5
线规 Wire gauge(mm <sup>2</sup> /AWG)	≤0.75/18	≤0.75/18

## 焊接芯件参数表 Welding core parameters table

芯数 Number of cores	4	5
公端绝缘体正面图 Front view of male insulator		
额定电流 Rated current(A)	3	5
接触件直径 Contact diameter(mm)	Φ0.7×4	Φ0.7×5
工作电压 Operating voltage(AC.V)	125	125
耐压 Withstand voltage(AC.V)1min	1000	1000
接触电阻 Contact resistance(mΩ)	10	10
线规 Wire gauge(mm <sup>2</sup> /AWG)	≤0.5/20	≤0.5/20



# SP13防水航空插系列 waterproof aviation socket series



防水航空插 waterproof aviation connector

电缆插头于SP1311、SP3112、SP1313适配  
Cable plug match with SP1311、SP3112、SP1313

电缆直径: I: 4-6.5mm(不标), II: 5-8mm  
Cable diameter: I: 4-6.5mm(not marked), II: 5-8mm

SP1310/ P      SP1310/ S

插针 Pin      插孔 Socket

电缆外径 Cable outer diameter  
芯数 Number of cores

后螺母插座与SP1310适配  
Rear nut socket match with SP1310

SP1312/P      SP1312/S

开孔尺寸 Mounting size

电缆对接插座与SP1310适配  
Cable butt socket match with SP1310

电缆直径: I: 4-6.5mm(不标), II: 5-8mm  
Cable diameter: I: 4-6.5mm(not marked), II: 5-8mm

SP1311/P      SP1311/S

法兰插座与SP1310适配  
Flange socket match with SP1310

SP1313/P      SP1313/S

开孔尺寸 Mounting size

焊接芯件参数表 Welding core parameters table

芯数 Number of cores	2	3	4	5	6	7	9
公端绝缘体正面图 Front view of male insulator							
额定电流 Rated current(A)	13	13	5	5	5	5	3
接触件直径 Contact diameter(mm)	Φ1.6×2	Φ1.6×3	Φ1×4	Φ1×5	Φ1×6	Φ1×7	Φ0.7×9
工作电压 Operating voltage(AC.V)	250	250	200	180	125	125	125
耐压 Withstand voltage(AC.V)1min	1500	1500	1500	1000	1000	1000	1000
接触电阻 Contact resistance(mΩ)	2.5	2.5	5	5	5	5	10
线规 Wire gauge(mm <sup>2</sup> /AWG)	≤2/14	≤2/14	≤0.75/18	≤0.75/18	≤0.75/18	≤0.75/18	≤0.5/20



# SP17防水航空插系列 waterproof aviation socket series



防水航空插 waterproof aviation connector



电缆插头  
与 SP1711、SP1712、  
SP1713、SP1714  
SP1715 相配  
Cable plug math with  
SP1711、SP1712、SP1713、  
SP1714、SP1715

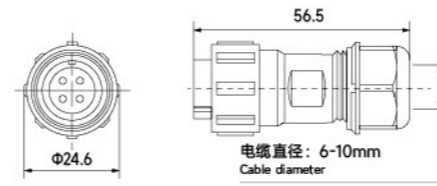

SP1710/ P      SP1710/ S  
插针 Pin      插孔 Socket

1: 焊接(不标)Welding(not marked), 3: 压接 Crimping  
芯数 Number of cores



后螺母插座  
与 SP1710、SP1716 相配  
Rear nut socket match  
with SP1710、SP1716

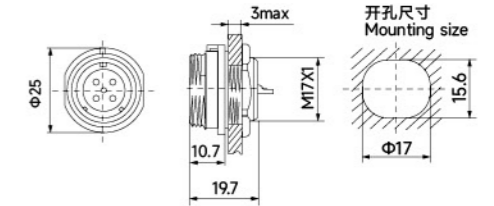

SP1712/P      SP1712/S



电缆对接插座  
与 SP1710、SP1716相配  
Cable butt socket match  
with SP1710、SP1716

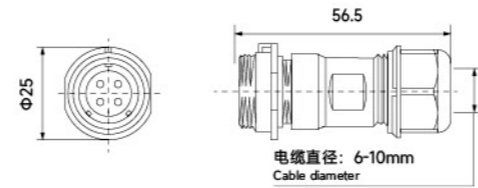

SP1711/P      SP1711/S

螺丝插座与  
SP1710、SP1716相配  
Screw socket match with  
SP1710、SP1716

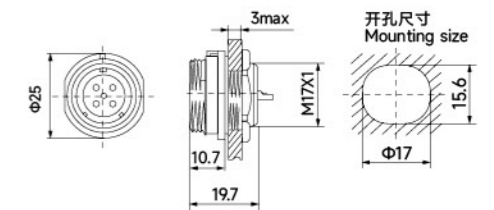

SP1713/P      SP1713/S

焊接芯件参数表 Welding core parameters table

芯数 Number of cores	2	3	4	5	7	9	10
公端绝缘体正面图 Front view of male insulator							
额定电流 Rated current(A)	10	10	5	5	5	5	5
接触件直径 Contact diameter(mm)	Φ1.5×2	Φ1.5×3	Φ1×4	Φ1×5	Φ1×7	Φ1×9	Φ1×10
工作电压 Operating voltage(AC.V)	500	500	500	500	400	400	400
耐压 Withstand voltage(AC.V)1min	1500	1500	1500	1500	1200	1200	1200
接触电阻 Contact resistance(mΩ)	2.5	2.5	5	5	5	5	5
线规 Wire gauge(mm <sup>2</sup> /AWG)	≤2/14	≤2/14	≤0.75/18	≤0.75/18	≤0.75/18	≤0.75/18	≤0.75/18



# SP21防水航空插系列 waterproof aviation socket series



19/20

防水航空插 waterproof aviation connector



电缆插头与SP2111、SP2112、  
SP2113、SP2114、SP2115 相配  
Cable plug match with  
SP2111、SP2112、SP2113、  
SP2114、SP2115

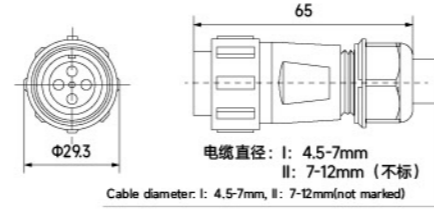

后螺母插座  
与 SP2110、SP2116 相配  
Rear nut socket match with  
SP2110、SP2116

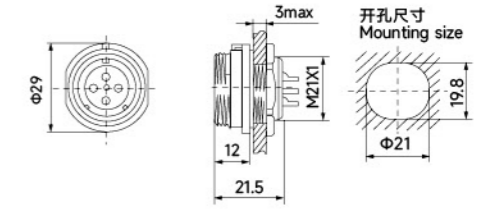

SP2110/ P  
SP2110/ S  
插针 Pin  
插孔 Socket

1: 焊接(不标)Welding(not marked), 2: 螺丝压接 Screw crimping, 3: 压接 Crimping  
电缆外接 Cable external connection  
芯数 Number of cores

SP2112/P

SP2112/S

1: 焊接(不标)Welding(not marked), 2: 螺丝压接 Screw crimping, 3: 压接 Crimping  
芯数 Number of cores



电缆对接插座  
与 SP2110、SP2116相配  
Cable butt socket match  
with SP2110、SP2116

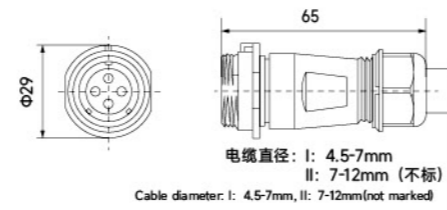

SP2111/P

SP2111/S



螺丝插座  
与SP2110,SP2116相配  
Screw socket match  
with SP2110、SP2116

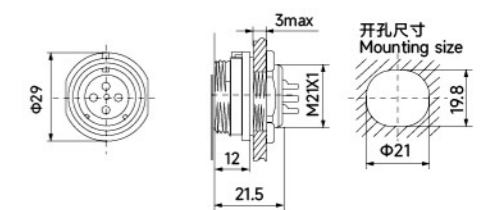

SP2113/P

SP2113/S

1: 焊接(不标)Welding(not marked), 2: 螺丝压接 Screw crimping, 3: 压接 Crimping  
芯数 Number of cores

## 焊接芯件参数表 Welding core parameters table

芯数 Number of cores	2	3	4	5	7	9	12
公端绝缘体正面图 Front view of male insulator							
额定电流 Rated current(A)	30   20	30   20	30   20	30   20	15	5	5
接触件直径 Contact diameter(mm)	Φ3×2	Φ3×3	Φ3×4	Φ3×5	Φ2×7	Φ1×9	Φ1×12
工作电压 Operating voltage(AC.V)	500	500	500	500	500	400	400
耐压 Withstand voltage(AC.V)1min	1500	1500	1500	1500	1500	1500	1200
接触电阻 Contact resistance(mΩ)	1	1	1	1	2.5	5	5
接线方式 Connection mode	焊接/螺丝压接 Welding/screw crimping	焊接/螺丝压接 Welding/screw crimping	焊接/螺丝压接 Welding/screw crimping	焊接/螺丝压接 Welding/screw crimping	焊接/螺丝压接 Welding/screw crimping	焊接 Welding	焊接 Welding
焊接线规 Welding wire gauge(mm <sup>2</sup> /AWG)	≤4/12	≤4/12	≤4/12	≤4/12	≤2/14	≤0.75/18	≤0.75/18
螺丝压接线规 Screw crimping wire gauge (mm <sup>2</sup> /AWG)	≤1.5/15	≤1.5/15	≤1.5/15	≤1.5/15	/	/	/



# SP29防水航空插系列 waterproof aviation socket series



防水航空插 waterproof aviation connector



电缆插头与 SP2911、SP2912  
SP2913、SP2914、SP2915相配  
Cable plug match with  
SP2911、SP2912、  
SP2913、SP2914、SP2915

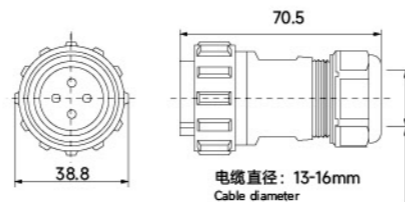

SP2910/ P      SP2910/ S

插针 Pin

1: 焊接(不标)Welding(not marked), 2: 螺丝压接 Screw crimping, 3: 压接 Crimping  
电缆外接 Cable external connection  
芯数 Number of cores  
插孔 Socket



后螺母插座  
与SP2910,SP2916 相配  
Rear nut socket match  
with SP2910、SP2916

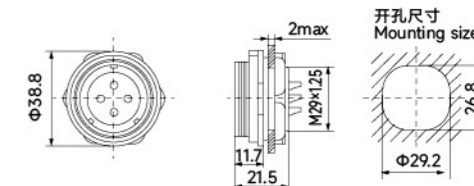

SP2912/P

SP2912/S

1: 焊接(不标)Welding(not marked), 2: 螺丝压接 Screw crimping, 3: 压接 Crimping  
芯数 Number of cores



电缆对接插座  
与 SP2910、SP2916相配  
Cable butt socket match  
with SP2910、SP2916

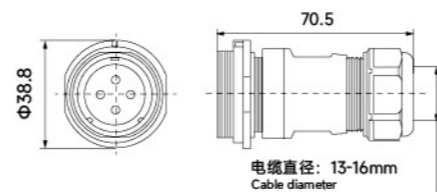

SP2911/P

SP2911/S



螺丝插座  
与 SP2910、SP2916相配  
Screw socket match  
with SP2910、SP2916

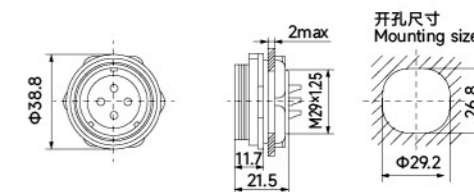

SP2913/P

SP2913/S

1: 焊接(不标)Welding(not marked), 2: 螺丝压接 Screw crimping, 3: 压接 Crimping  
芯数 Number of cores

## 焊接芯件参数表 Welding core parameters table

芯数 Number of cores	2	3	4	5	7	9	12
公端绝缘体正面图 Front view of male insulator							
额定电流 Rated current(A)	30   20	30   20	30   20	30   20	15	5	5
接触件直径 Contact diameter(mm)	Φ3×2	Φ3×3	Φ3×4	Φ3×5	Φ2×7	Φ1×9	Φ1×12
工作电压 Operating voltage(AC.V)	500	500	500	500	500	400	400
耐压 Withstand voltage(AC.V)1min	1500	1500	1500	1500	1500	1500	1200
接触电阻 Contact resistance(mΩ)	1	1	1	1	2.5	5	5
接线方式 Connection mode	焊接/螺丝压接 Welding/screw crimping	焊接/螺丝压接 Welding/screw crimping	焊接/螺丝压接 Welding/screw crimping	焊接/螺丝压接 Welding/screw crimping	焊接/螺丝压接 Welding/screw crimping	焊接 Welding	焊接 Welding
焊接线规 Welding wire gauge(mm <sup>2</sup> /AWG)	≤4/12	≤4/12	≤4/12	≤4/12	≤2/14	≤0.75/18	≤0.75/18
螺丝压接线规 Screw crimping wire gauge (mm <sup>2</sup> /AWG)	≤1.5/15	≤1.5/15	≤1.5/15	≤1.5/15	/	/	/





# 221 系列 Series



快速连接器 Quick wire connector



手柄颜色可定制  
Handle color can be customized

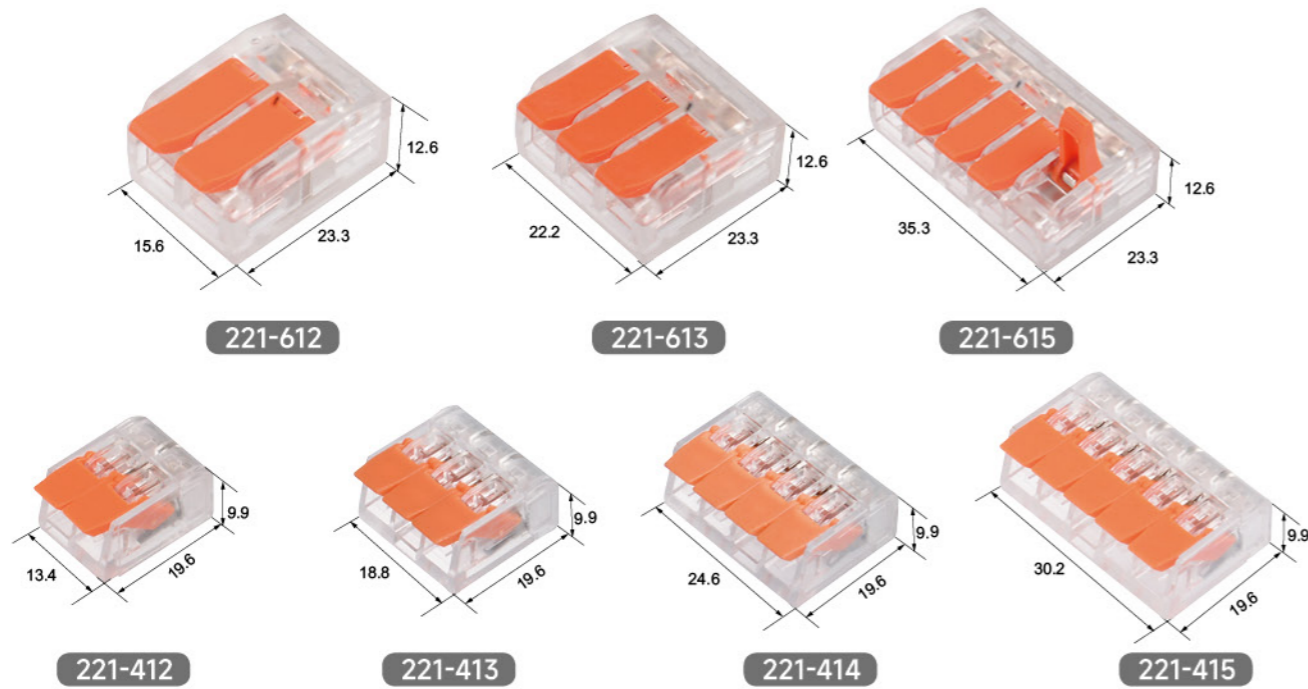

- 操作便捷 - 向上扳动操作手柄，插入导线，随后将手柄扳回原位
  - 可提供2, 3, 4, 5线连接器
  - 可轻松连接截面积介于0.2-4.0 mm<sup>2</sup>范围内的导线
  - 连接单股、多股绞合和细多股导线
  - 为安装人员和设备制造商节省时间
  - 可快速连接更大功率的设备
- Easy operation - Pull the handle up, insert the wire, and then pull the handle back in position
  - Available with 2, 3, 4, and 5-wire connectors
  - Easily connect wires with cross-sectional areas ranging from 0.2-4.0 mm<sup>2</sup>
  - Connect single strand, multiple strand and thin multiple strand wires
  - Save time for installers and equipment manufacturers
  - Connect more powerful devices quickly

产品型号 Product model	孔数 Hole number	额定电压 Rated voltage	额定电流 Rated current	实心导线 Solid wire BV	多股导线 Multiple conductor BVR/RV	剥线长度 Strip length	材质 Material
221-412	2	250V	32A	0.2-4.0mm <sup>2</sup>	0.2-4.0mm <sup>2</sup>	11 mm / 0.43 inches	外壳 Shell: PC 手柄 Handle: PA 导体 Electric conductor: 紫铜 Red copper 弹簧扣 Spring fastener: 301
221-413	3						
221-414	4						
221-415	5						
221-612	2						
221-613	3	250V	40A	0.5-6.0mm <sup>2</sup>	0.5-6.0mm <sup>2</sup>	14 mm / 0.55 inches	
221-615	5						



# 222 系列 Series

# 23/24

快速连接器 Quick wire connector



手柄颜色可定制  
Handle color can be customized

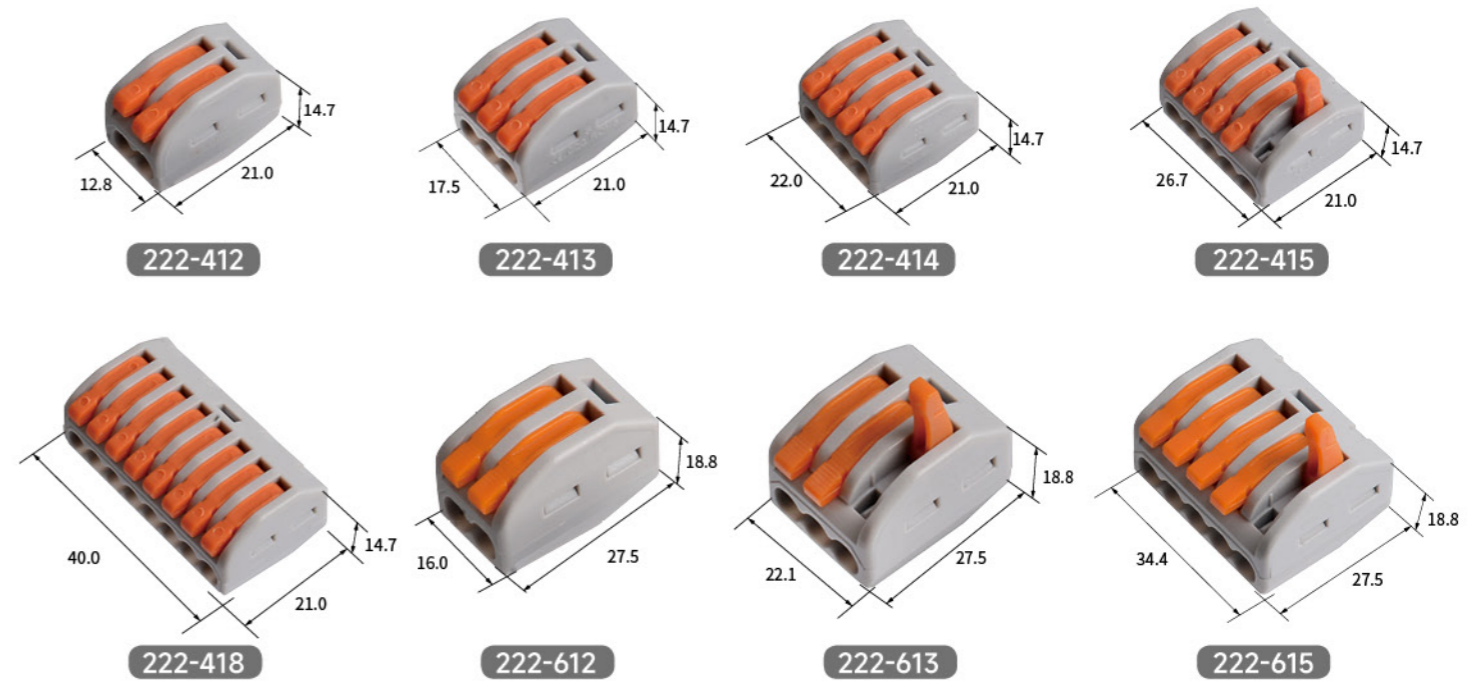

- 操作便捷 - 向上扳动操作手柄，插入导线，随后将手柄扳回原位
  - 可提供2, 3, 4, 5, 8线连接器
  - 可轻松连接截面积介于0.08-4.0mm<sup>2</sup>范围内的导线
  - 连接单股、多股绞合和细多股导线
  - 为安装人员和设备制造商节省时间
  - 可快速连接更大功率的设备
- Easy operation - Pull the handle up, insert the wire, and then pull the handle back in position
  - Available with 2, 3, 4, 5, 8-wire connectors
  - Easily connect wires with cross-sectional areas ranging from 0.08 to 4.0 mm<sup>2</sup>
  - Connect single strand, multiple strand and thin multiple strand wires
  - Save time for installers and equipment manufacturers
  - Connect more powerful devices quickly

产品型号 Product model	孔数 Hole number	额定电压 Rated voltage	额定电流 Rated current	实心导线 Solid wire BV	多股导线 Multiple conductor BVR/RV	剥线长度 Strip length	材质 Material
222-412	2	250V	32A	0.08-4.0mm <sup>2</sup>	0.08-2.5mm <sup>2</sup>	10 mm / 0.39 inches	外壳 Shell: PC 或 PA 手柄 Handle: PC或或 PA 导体 Electric conductor: 紫铜 Red copper 弹簧扣 Spring fastener: 301
222-413	3						
222-414	4						
222-415	5						
222-418	8						
222-612	2	250V	35A	0.5-6.0mm <sup>2</sup>	0.5-6.0mm <sup>2</sup>	12 mm / 0.47 inches	
222-613	3						
222-615	5						



# 222-22MINI 系列 Series



快速连接器 Quick wire connector



手柄颜色可定制  
Handle color can be customized

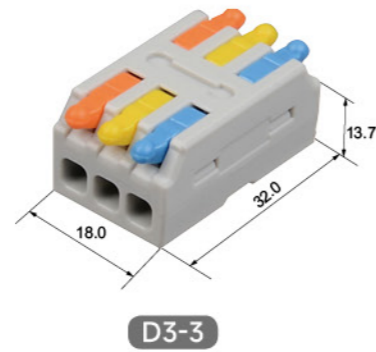

- 操作便捷 - 向上扳动操作手柄，插入导线，随后将手柄扳回原位
- 可提供4, 6线连接器
- 可轻松连接截面积介于0.08-4.0mm<sup>2</sup>范围内的导线
- 连接单股、多股绞合和细多股导线
- 为安装人员和设备制造商节省时间
- 可快速连接更大功率的设备

- Easy operation - Pull the handle up, insert the wire, and then pull the handle back in position
- Available with 4, 6-wire connectors
- Easily connect wires with cross-sectional areas ranging from 0.08 to 4.0 mm<sup>2</sup>
- Connect single strand, multiple strand and thin multiple strand wires
- Save time for installers and equipment manufacturers
- Connect more powerful devices quickly

产品型号 Product model	孔数 Hole number	额定电压 Rated voltage	额定电流 Rated current	实心导线 Solid wire BV	多股导线 Multiple conductor BVR/RV	剥线长度 Strip length	材质 Material
D2-2	4	250V	32A	0.08-4.0mm <sup>2</sup> 28-12AWG	0.08-2.5mm <sup>2</sup> 28-14AWG	10 mm / 0.39 inches	外壳 Shell: PC 手柄 Handle: PC 导体 Electric conductor: 紫铜 Red copper 弹簧扣 Spring fastener: 301
D3-3	6						



# 222-2 系列 Series

快速连接器 Quick wire connector



手柄颜色可定制  
Handle color can be customized

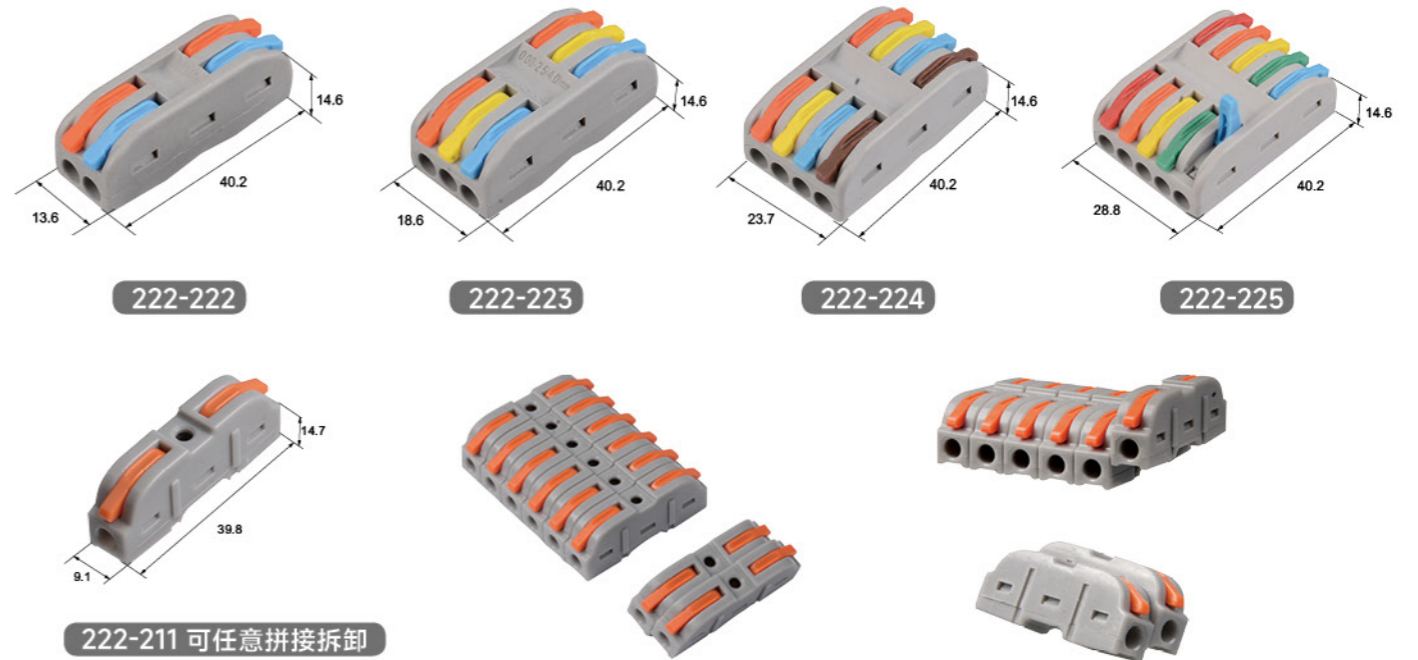

222-211 可任意拼接拆卸  
Can be arbitrarily spliced and disassembled

- 操作便捷 - 向上扳动操作手柄，插入导线，随后将手柄扳回原位
- 可提供2, 4, 6, 8, 10线连接器
- 可轻松连接截面积介于0.08-4.0mm<sup>2</sup>范围内的导线
- 连接单股、多股绞合和细多股导线
- 为安装人员和设备制造商节省时间
- 可快速连接更大功率的设备

- Easy operation - Pull the handle up, insert the wire, and then pull the handle back in position
- Available with 2, 4, 6, 8, and 10-wire connectors
- Easily connect wires with cross-sectional areas ranging from 0.08 to 4.0 mm<sup>2</sup>
- Connect single strand, multiple strand and thin multiple strand wires
- Save time for installers and equipment manufacturers
- Connect more powerful devices quickly

产品型号 Product model	孔数 Hole number	额定电压 Rated voltage	额定电流 Rated current	实心导线 Solid wire BV	多股导线 Multiple conductor BVR/RV	剥线长度 Strip length	材质 Material
222-211	2	250V	32A	0.08-4.0mm <sup>2</sup> 28-12AWG	0.08-2.5mm <sup>2</sup> 28-14AWG	10 mm / 0.39 inches	外壳 Shell: PC 或 PA 手柄 Handle: PC 或 PA 导体 Electric conductor: 紫铜 Red copper 弹簧扣 Spring fastener: 301
222-222	4						
222-223	6						
222-224	8						
222-225	10						



# 222-22 系列 Series



快速连接器 Quick wire connector



手柄颜色可定制  
Handle color can be customized

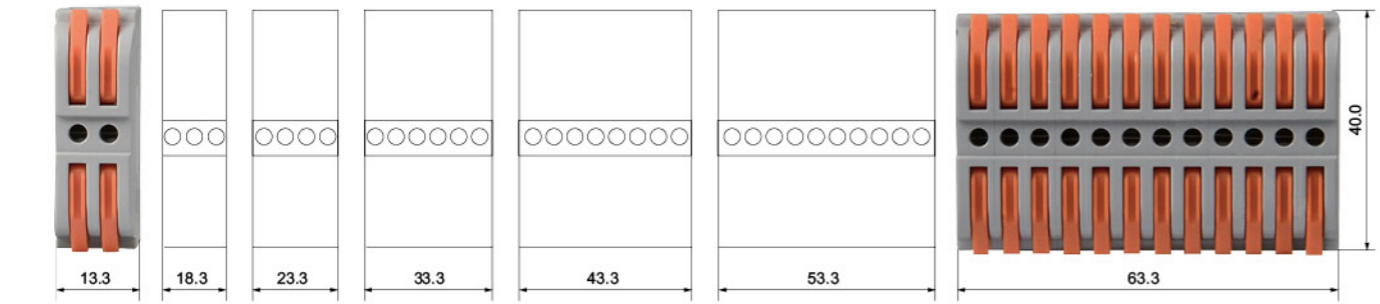

222-22 高度统一为 Highly unified as: 15.6

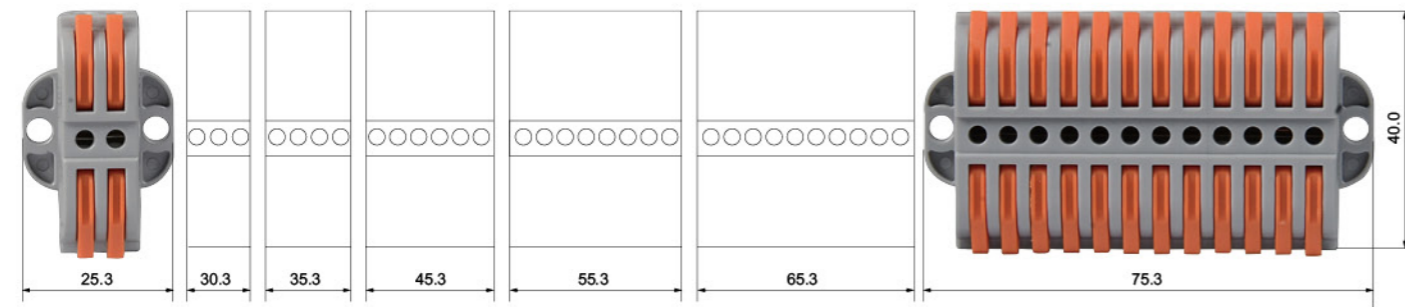

222-22G 高度统一为 Highly unified as: 15.6

- 操作便捷 - 向上扳动操作手柄，插入导线，随后将手柄扳回原位
- 可提供2, 4, 6, 8, 10线连接器
- 可轻松连接截面积介于0.08-4.0mm<sup>2</sup>范围内的导线
- 连接单股、多股绞合和细多股导线
- 为安装人员和设备制造商节省时间
- 可快速连接更大功率的设备
- Easy operation - Pull the handle up, insert the wire, and then pull the handle back in position
- Available with 2, 4, 6, 8, and 10-wire connectors
- Easily connect wires with cross-sectional areas ranging from 0.08 to 4.0 mm<sup>2</sup>
- Connect single strand, multiple strand and thin multiple strand wires
- Save time for installers and equipment manufacturers
- Connect more powerful devices quickly

产品型号 Product model	孔数 Hole number	额定电压 Rated voltage	额定电流 Rated current	实心导线 Solid wire BV	多股导线 Multiple conductor BVR/RV	剥线长度 Strip length	材质 Material
222-22	2-12	250V	32A	0.08-4.0mm <sup>2</sup> 28-12AWG	0.08-2.5mm <sup>2</sup> 28-14AWG	10 mm / 0.39 inches	外壳 Shell: PC 或 or PA 手柄 Handle: PC 或 or PA 导体 Electric conductor: 紫铜 Red copper
222-22G	2-12						弹簧扣 Spring fastener: 301

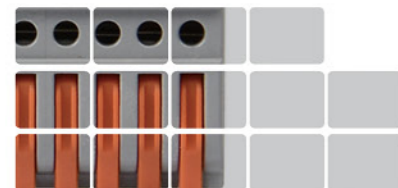

# 分线系列 Branch series

快速连接器 Quick wire connector



手柄颜色可定制  
Handle color can be customized

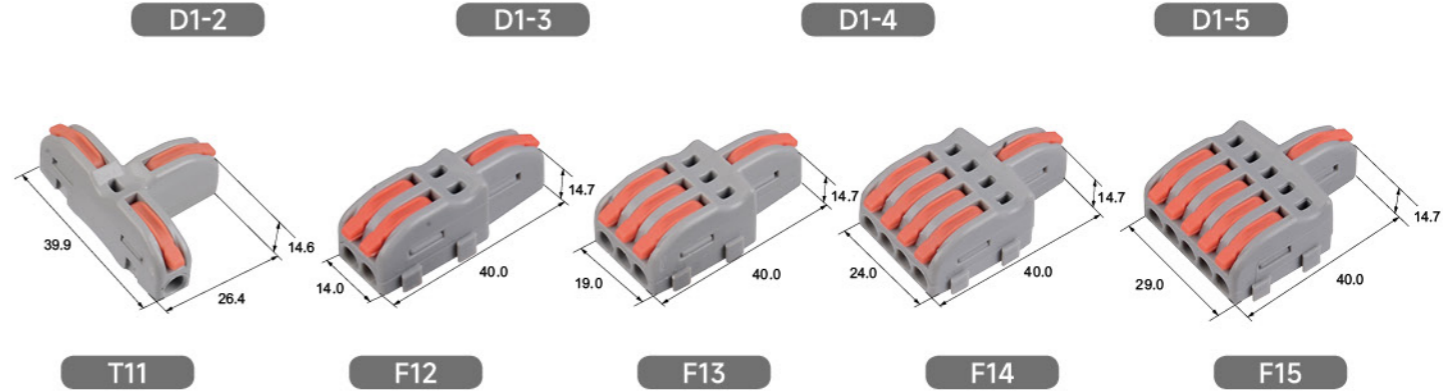
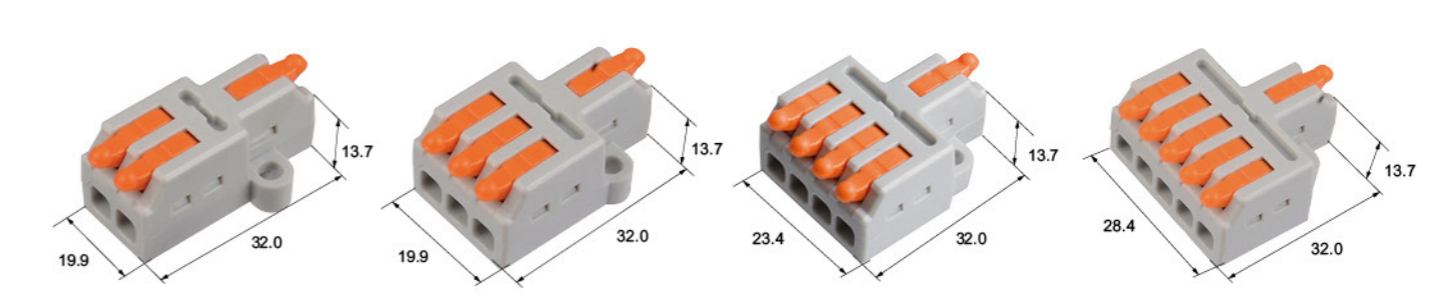

- 操作便捷 - 向上扳动操作手柄，插入导线，随后将手柄扳回原位
- 可提供分线1进2/3/4/5出
- 可轻松连接截面积介于0.08-4.0mm<sup>2</sup>范围内的导线
- 连接单股、多股绞合和细多股导线
- 为安装人员和设备制造商节省时间
- 可快速连接更大功率的设备
- Easy operation - Pull the handle up, insert the wire, and then pull the handle back in position
- It can provide 1 in 2/3/4/5 out
- Easily connect wires with cross-sectional areas ranging from 0.08 to 4.0 mm<sup>2</sup>
- Connect single strand, multiple strand and thin multiple strand wires
- Save time for installers and equipment manufacturers
- Connect more powerful devices quickly

产品型号 Product model	孔数 Hole number	额定电压 Rated voltage	额定电流 Rated current	实心导线 Solid wire BV	多股导线 Multiple conductor BVR/RV	剥线长度 Strip length	材质 Material
D1-2	3	250V	32A	0.08-4.0mm <sup>2</sup> 28-12AWG	0.08-2.5mm <sup>2</sup> 28-14AWG	10 mm / 0.39 inches	外壳 Shell: PC 或 or PA 手柄 Handle: PC 或 or PA 导体 Electric conductor: 紫铜 Red copper
D1-3	4						
D1-4	5						
D1-5	6						
T11	3						
F12	3	250V	32A	0.08-4.0mm <sup>2</sup> 28-12AWG	0.08-2.5mm <sup>2</sup> 28-14AWG	10 mm / 0.39 inches	导体 Electric conductor: 紫铜 Red copper
F13	4						
F14	5						
F15	6						弹簧扣 Spring fastener: 301



# 分线系列 Branch series



快速连接器 Quick wire connector



手柄颜色可定制  
Handle color can be customized

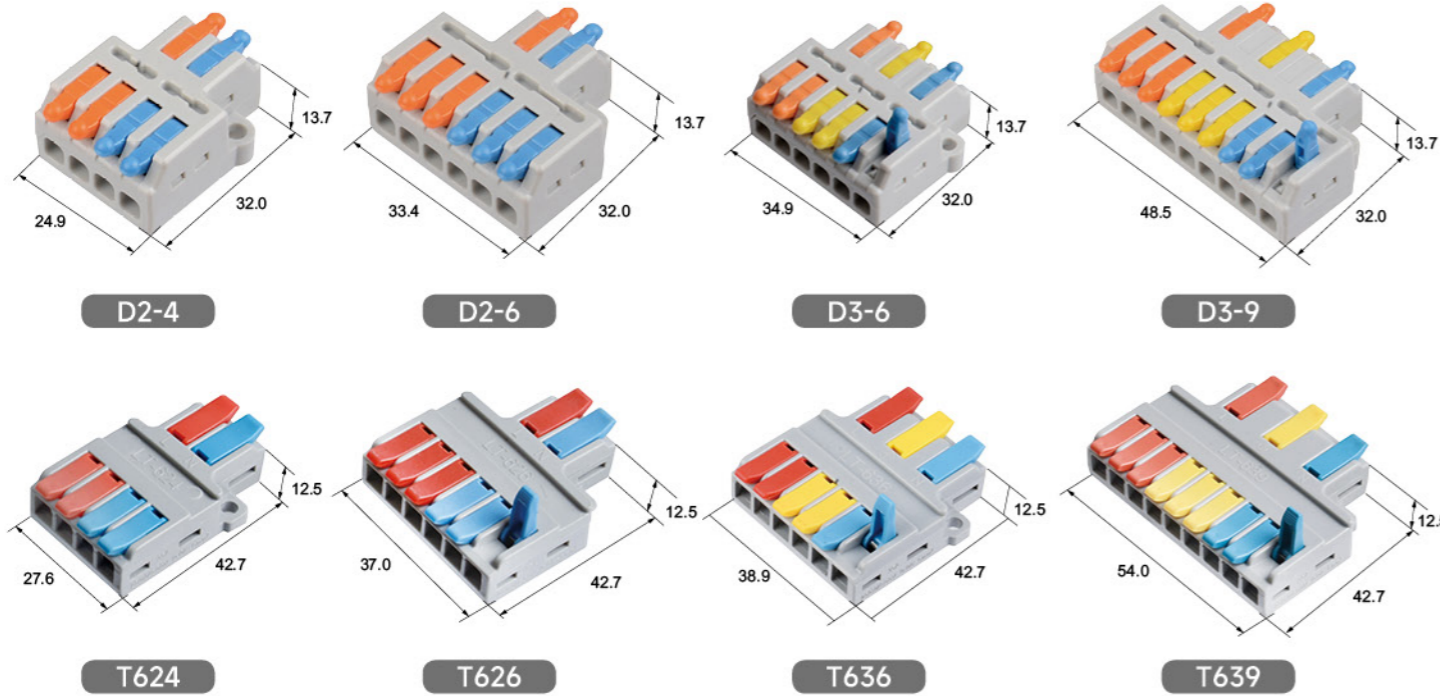

- 操作便捷 - 向上扳动操作手柄，插入导线，随后将手柄扳回原位
- 可提供分线2进4/6出 3进6/9出
- 可轻松连接截面积介于0.08-6.0mm<sup>2</sup>范围内的导线
- 连接单股、多股绞合和细多股导线
- 为安装人员和设备制造商节省时间
- 可快速连接更大功率的设备

产品型号 Product model	孔数 Hole number	额定电压 Rated voltage	额定电流 Rated current	实心导线 Solid wire BV	多股导线 Multiple conductor BVR/RV	剥线长度 Strip length	材质 Material
D2-4	6	250V	32A	0.08-4.0mm <sup>2</sup> 28-12AWG	0.08-2.5mm <sup>2</sup> 28-14AWG	10 mm / 0.39 inches	外壳 Shell: PC 或 PA 手柄 Handle: PC 或 PA 导体 Electric conductor: 紫铜 Red copper 弹簧扣 Spring fastener: 301
D2-6	8						
D3-6	9						
D3-9	12						
T624	6	35A		0.08-6.0mm <sup>2</sup> 28-10AWG	0.08-6.0mm <sup>2</sup> 28-10AWG	12 mm / 0.47 inches	
T626	8						
T636	9						
T639	12						



# 分线系列 Branch series

快速连接器 Quick wire connector



手柄颜色可定制  
Handle color can be customized

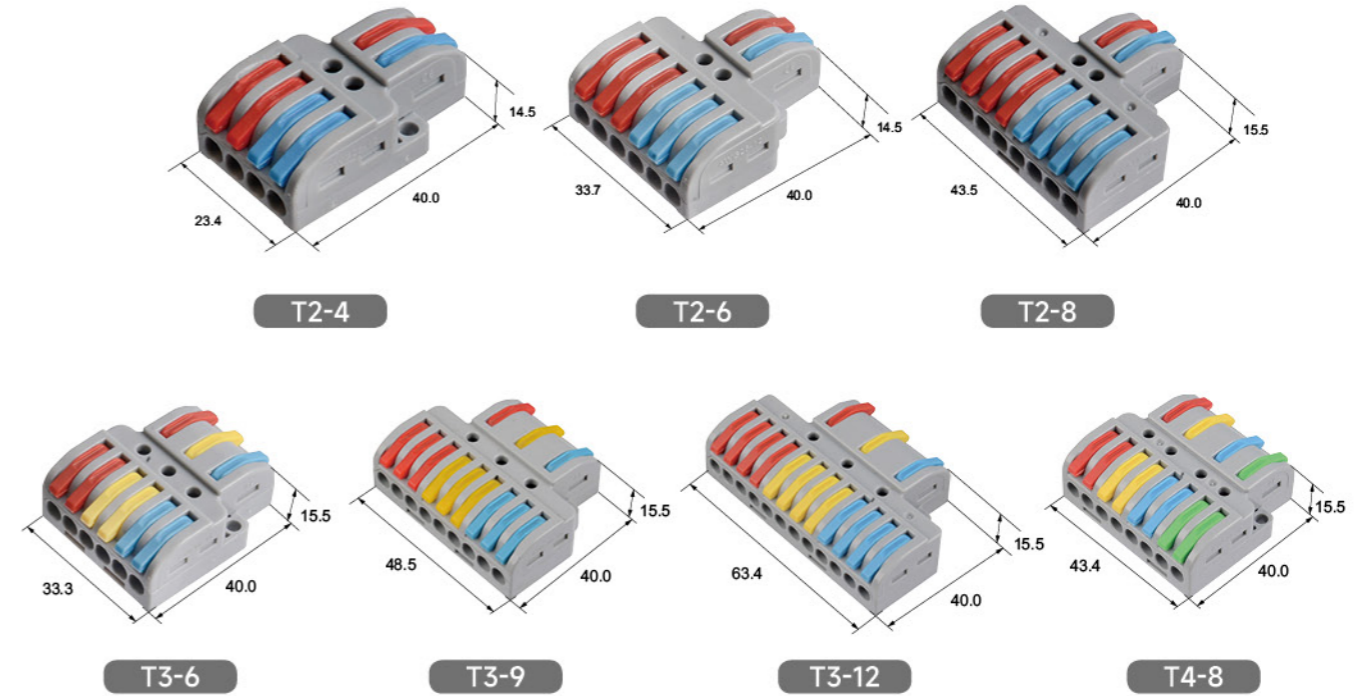

- 操作便捷 - 向上扳动操作手柄，插入导线，随后将手柄扳回原位
- 可提供分线2进4/6/8出 3进6/9/12出 4进8出
- 可轻松连接截面积介于0.08-4.0mm<sup>2</sup>范围内的导线
- 连接单股、多股绞合和细多股导线
- 为安装人员和设备制造商节省时间
- 可快速连接更大功率的设备

产品型号 Product model	孔数 Hole number	额定电压 Rated voltage	额定电流 Rated current	实心导线 Solid wire BV	多股导线 Multiple conductor BVR/RV	剥线长度 Strip length	材质 Material
T2-4	6	250V	32A	0.08-4.0mm <sup>2</sup> 28-12AWG	0.08-2.5mm <sup>2</sup> 28-14AWG	10 mm / 0.39 inches	外壳 Shell: PC 或 PA 手柄 Handle: PC 或 PA 导体 Electric conductor: 紫铜 Red copper 弹簧扣 Spring fastener: 301
T2-6	8						
T2-8	10						
T3-6	9						
T3-9	12						
T3-12	15						
T4-8	12						

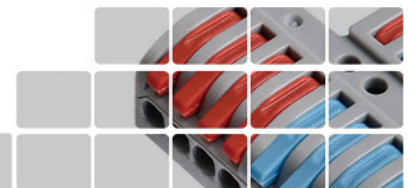

# 2604 系列 series



快速连接器 Quick wire connector



手柄颜色可定制  
Handle color can be customized

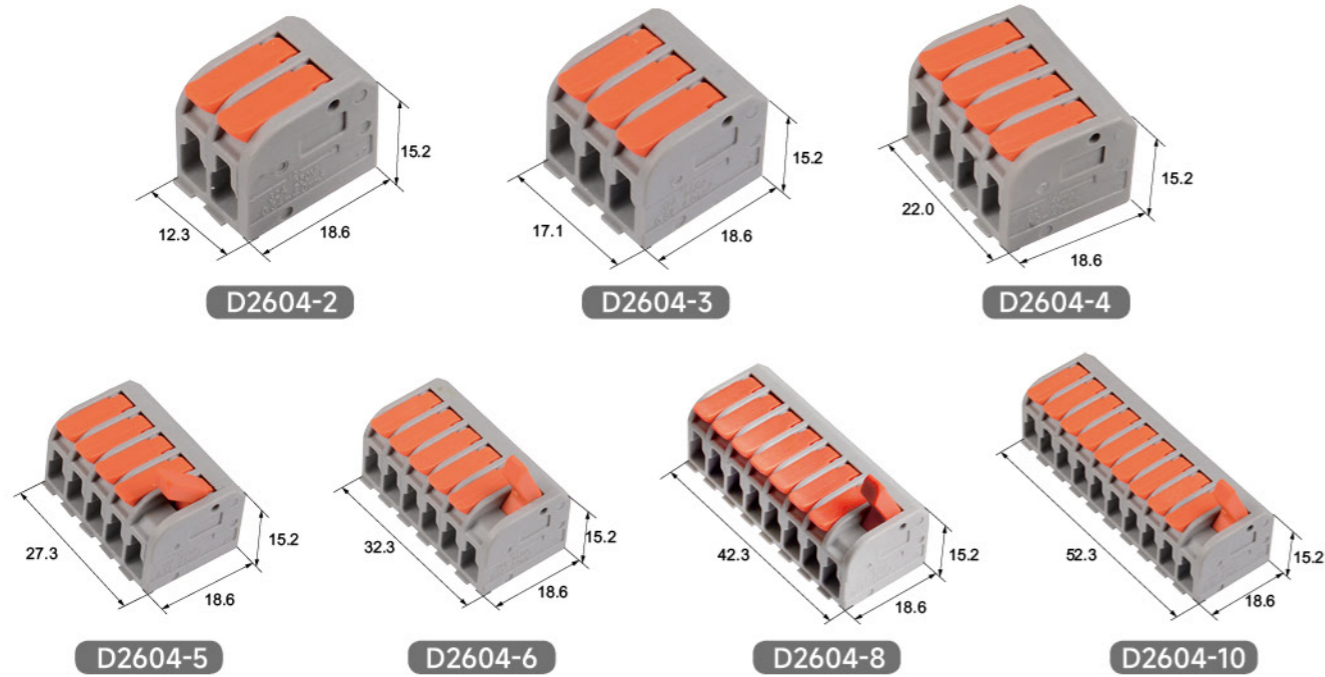

- 操作便捷 - 向上扳动操作手柄，插入导线，随后将手柄扳回原位
- 可提供2, 3, 4, 5, 6, 8, 10线连接器
- 可轻松连接截面积介于0.2-4.0 mm<sup>2</sup>范围内的导线
- 连接单股、多股绞合和细多股导线
- 和221系列功能一致，手柄感觉更轻
- 可快速连接更大功率的设备

- Easy operation - Pull the handle up, insert the wire, and then pull the handle back in position
- Available with 2,3,4, 5, 6, 8, and 10-wire connectors
- Easily connect wires with cross-sectional areas ranging from 0.2-4.0 mm<sup>2</sup>
- Connect single strand, multiple strand and thin multiple strand wires
- As with the 221 series, the handle feels lighter
- Connect more powerful devices quickly

产品型号 Product model	孔数 Hole number	额定电压 Rated voltage	额定电流 Rated current	实心导线 Solid wire BV	多股导线 Multiple conductor BVR/RV	剥线长度 Strip length	材质 Material
D2604-2	2	250V	32A	0.2-4.0mm <sup>2</sup> 24-12AWG	0.2-2.5mm <sup>2</sup> 24-14AWG	12 mm / 0.47 inches	外壳 Shell: PC 或 PA 手柄 Handle: PC 或 PA 导体 Electric conductor: 紫铜 Red copper 弹簧扣 Spring fastener: 301
D2604-3	3						
D2604-4	4						
D2604-5	5						
D2604-6	6						
D2604-8	8						
D2604-10	10						



# 2604D系列 series

快速连接器 Quick wire connector



手柄颜色可定制  
Handle color can be customized

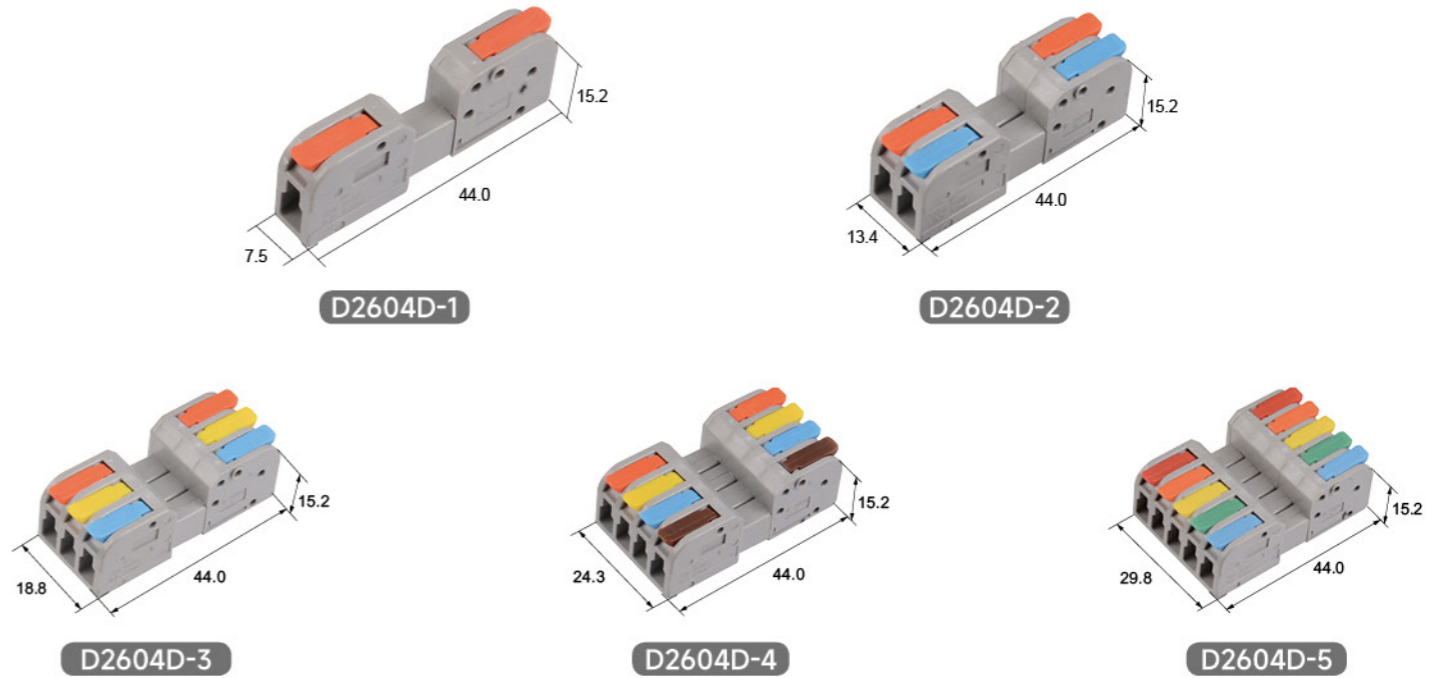

- 公母插拔型连接器
- 操作便捷 - 向上扳动操作手柄，插入导线，随后将手柄扳回原位
- 可提供2, 4, 6, 8, 10线连接器
- 可轻松连接截面积介于0.2-4.0mm<sup>2</sup>范围内的导线
- 连接单股、多股绞合和细多股导线
- 可快速连接更大功率的设备

- Male and female plug type connector
- Easy operation - Pull the handle up, insert the wire, and then pull the handle back in position
- Available with 2, 4, 6, 8, and 10-wire connectors
- Easily connect wires with cross-sectional areas ranging from 0.2-4.0 mm<sup>2</sup>
- Connect single strand, multiple strand and thin multiple strand wires
- Connect more powerful devices quickly

产品型号 Product model	孔数 Hole number	额定电压 Rated voltage	额定电流 Rated current	实心导线 Solid wire BV	多股导线 Multiple conductor BVR/RV	剥线长度 Strip length	材质 Material
D2604D-1	2	250V	32A	0.2-4.0mm <sup>2</sup> 24-12AWG	0.2-2.5mm <sup>2</sup> 24-14AWG	12 mm / 0.47 inches	外壳 Shell: PC 或 PA 手柄 Handle: PC 或 PA 导体 Electric conductor: 紫铜 Red copper 弹簧扣 Spring fastener: 301
D2604D-2	4						
D2604D-3	6						
D2604D-4	8						
D2604D-5	10						



# 773-10 系列 series



快速连接器 Quick wire connector



去除导线绝缘部分 12mm  
Remove wire insulation

对准孔位插入导线  
Insert the wire into the hole

完成  
complete

左右旋转导线 即可完成分离  
Rotating conductor Separation can be completed

手柄颜色可定制  
Handle color can be customized

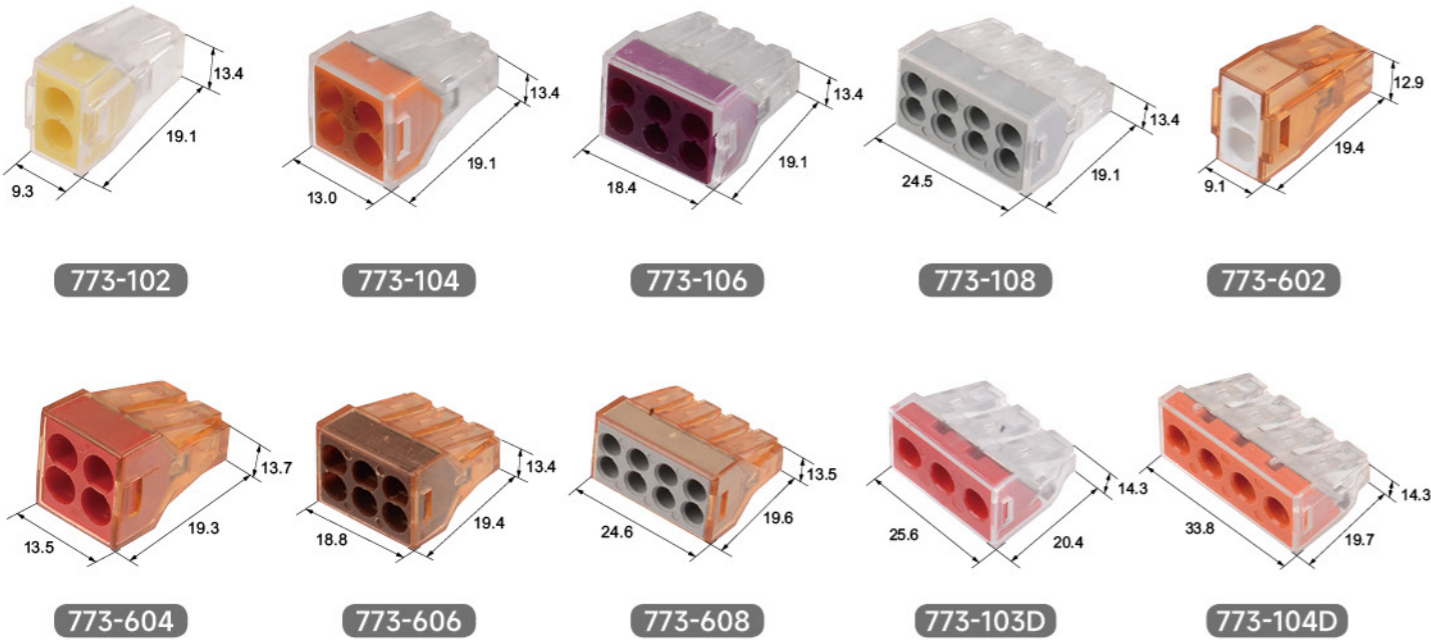

- 操作便捷 - 将导线插入孔中，推入到位，完成
- 可提供2, 3, 4, 6, 8线连接器
- 可轻松连接截面积介于0.75-4.0mm<sup>2</sup>范围内的导线
- 连接单股、多股绞合导线，细多股导线可搭配VE端子使用
- 为安装人员和设备制造商节省时间
- 可快速连接更大功率的设备

- Easy to operate - Insert the wire into the hole, push it into place and finish
- Available with 2, 3, 4, 6, 8-wire connectors
- Easily connect wires with cross-sectional areas ranging from 0.75 to 4.0 mm<sup>2</sup>
- Connect single-stranded and multi-stranded cables. Thin multi-stranded cables can be used with VE terminals
- Save time for installers and equipment manufacturers
- Connect more powerful devices quickly

产品型号 Product model	孔数 Hole number	额定电压 Rated voltage	额定电流 Rated current	实心导线 Solid wire BV	多股导线 Multiple conductor BVR/RV	剥线长度 Strip length	材质 Material	
773-102	2	250V	24A	0.75-2.5mm <sup>2</sup>	1.5-2.5mm <sup>2</sup>	12 mm / 0.47 inches	外壳 Shell: PC 手柄 Handle: PA 导体 Electric conductor: 紫铜 Red copper 弹簧扣 Spring fastener: 301	
773-104	4			32A	1.5-4.0mm <sup>2</sup>			1.5-4.0mm <sup>2</sup>
773-106	6				16-12AWG			16-12AWG
773-108	8							2.5-6.0mm <sup>2</sup>
773-602	2				41A			
773-604	4		16-12AWG	16-12AWG				
773-606	6							2.5-6.0mm <sup>2</sup>
773-608	8		12-10AWG	12-10AWG				
773-103D	3				12-10AWG			12-10AWG
773-104D	4							



# 773-20-30 系列 series

快速连接器 Quick wire connector



去除导线绝缘部分 12mm  
Remove wire insulation

对准孔位插入导线  
Insert the wire into the hole

完成  
complete

左右旋转导线 即可完成分离  
Rotating conductor Separation can be completed

手柄颜色可定制  
Handle color can be customized

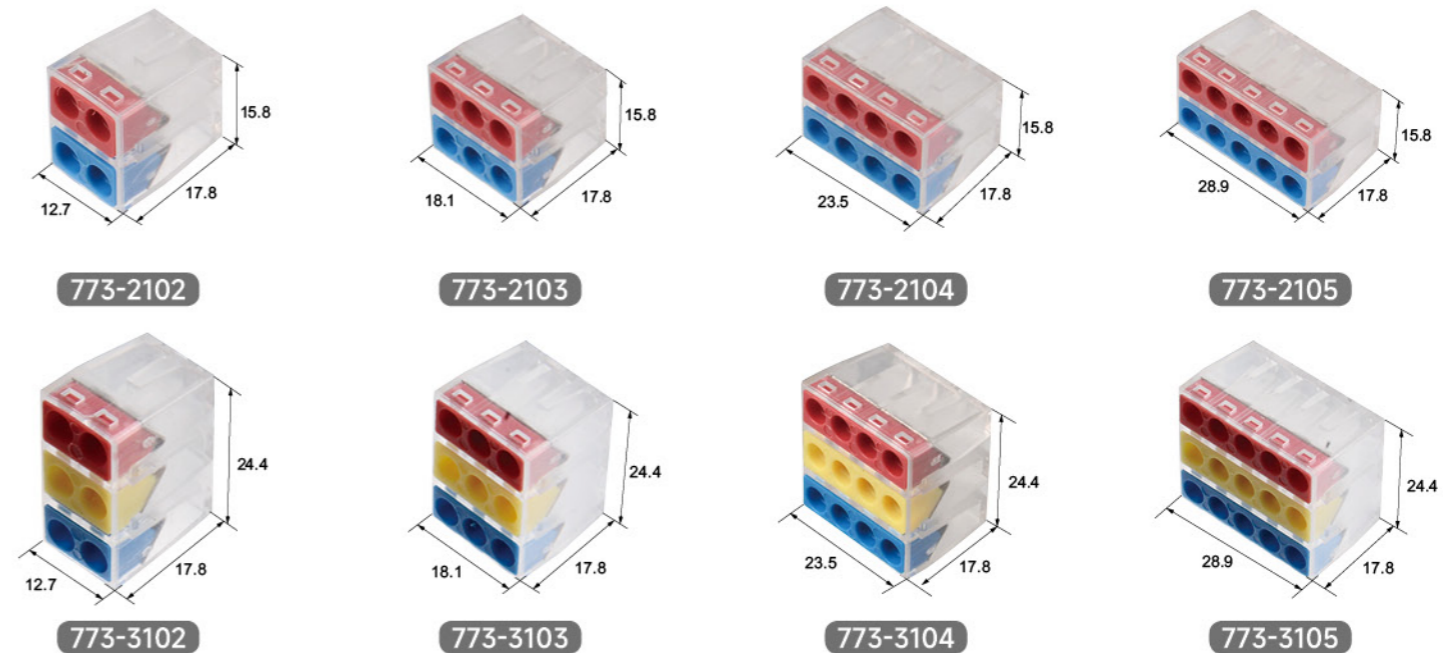

- 操作便捷 - 将导线插入孔中，推入到位，完成
- 可提供4, 6, 8, 9, 10, 12, 15线连接器
- 可轻松连接截面积介于0.75-2.5mm<sup>2</sup>范围内的导线
- 连接单股、多股绞合导线，细多股导线可搭配VE端子使用
- 为安装人员和设备制造商节省时间
- 可快速连接更大功率的设备

- Easy to operate - Insert the wire into the hole, push it into place and finish
- Available with 4,6,8,9,10, 12, 15 wire connectors
- Easily connect wires with cross-sectional areas ranging from 0.75 to 2.5 mm<sup>2</sup>
- Connect single-stranded and multi-stranded cables. Thin multi-stranded cables can be used with VE terminals
- Save time for installers and equipment manufacturers
- Connect more powerful devices quickly

产品型号 Product model	孔数 Hole number	额定电压 Rated voltage	额定电流 Rated current	实心导线 Solid wire BV	多股导线 Multiple conductor BVR/RV	剥线长度 Strip length	材质 Material
773-2102	4	250V	24A	0.75-2.5mm <sup>2</sup>	1.5-2.5mm <sup>2</sup>	12 mm / 0.47 inches	外壳 Shell: PC 手柄 Handle: PA 导体 Electric conductor: 紫铜 Red copper 弹簧扣 Spring fastener: 301
773-2103	6						
773-2104	8						
773-2105	10						
773-3102	6						
773-3103	9						
773-3104	12						
773-3105	15						

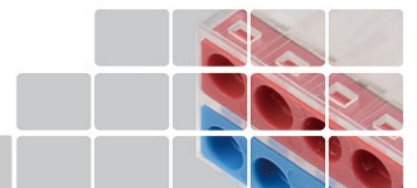

# 012 系列 series



## 快速连接器 Quick wire connector



去除导线绝缘部分 10mm Remove wire skin  
 按压外壳 Press case  
 插入电线 Insert wire  
 松手, 完成接线 Let go. Finish wiring

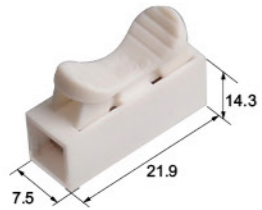

012-1

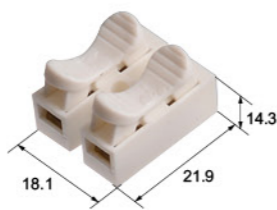

012-2



012-3

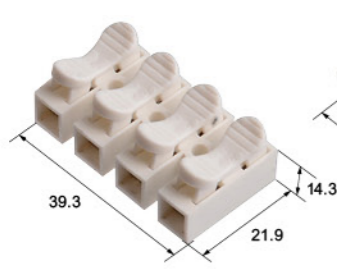

012-4

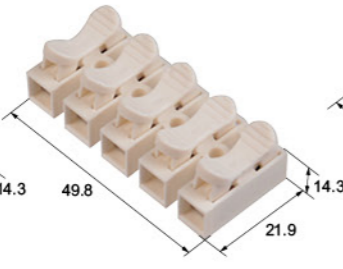

012-5

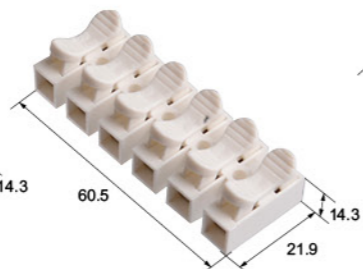

012-6

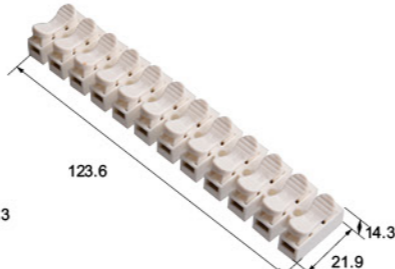

012-12

- 操作便捷 - 按压产品, 插入导线, 完成
- 可提供 2, 4, 6, 8, 10, 12, 24 线连接器
- 可轻松连接截面积介于 0.5-2.5mm<sup>2</sup> 范围内的导线
- 连接单股、多股绞合和细多股导线
- 为安装人员和设备制造商节省时间
- 可快速连接更大功率的设备

- Easy to operate - press the product, insert the wire, and done
- Available with 2, 4, 6, 8, 10, 12, 24-wire connectors
- Wires with cross-sectional areas ranging from 0.5 to 2.5 mm<sup>2</sup> can be easily connected
- Connect single strand, multiple strand and thin multiple strand wires
- Save time for installers and equipment manufacturers
- Connect more powerful devices quickly

产品型号 Product model	孔数 Hole number	额定电压 Rated voltage	额定电流 Rated current	实心导线 Solid wire BV	多股导线 Multiple conductor BVR/RV	剥线长度 Strip length	材质 Material
012-1	2	250V	5A	0.5-2.5mm <sup>2</sup> 20-14AWG	0.5-2.5mm <sup>2</sup> 20-14AWG	10 mm / 0.39 inches	外壳 Shell: PA 弹簧扣 Spring fastener: 301
012-2	4						
012-3	6						
012-4	8						
012-5	10						
012-6	12						
012-12	24						



# 照明器具用连接器系列 Connector series for lighting appliances

## 快速连接器 Quick wire connector



去除导线绝缘部分 10mm Remove wire skin  
 按压外壳 Press case  
 插入电线 Insert wire  
 松手, 完成接线 Let go. Finish wiring

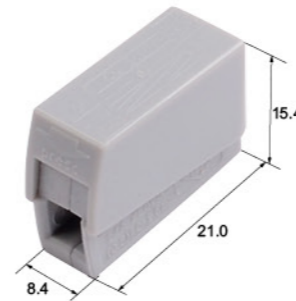

E-101

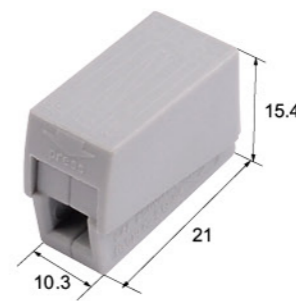

E-112

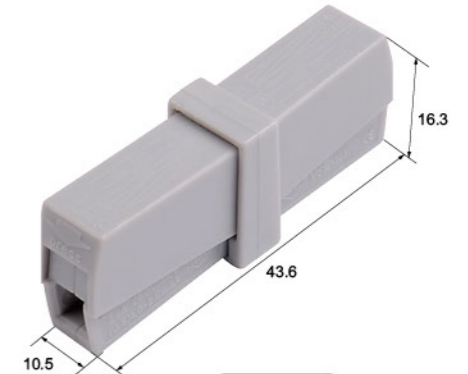

E-121

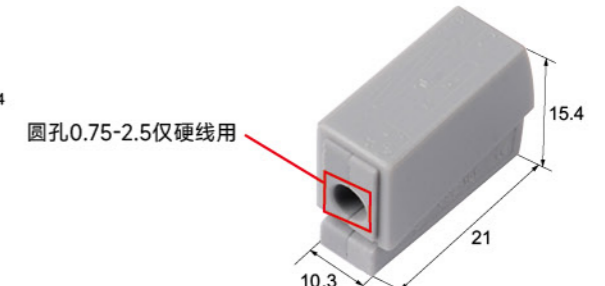
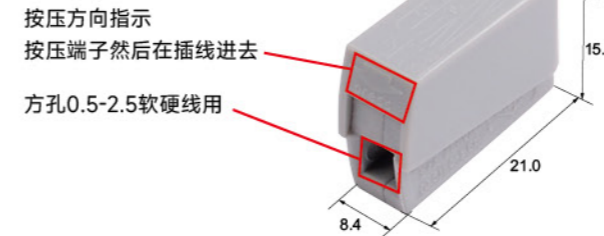

- 操作便捷 - 按压产品, 插入导线, 完成
- 可提供 2, 3 线连接器
- 可轻松连接截面积介于 0.5-2.5mm<sup>2</sup> 范围内的导线
- 连接单股、多股绞合和细多股导线
- 为安装人员和设备制造商节省时间
- 可快速连接更大功率的设备

- Easy to operate - press the product, insert the wire, and done
- 2, 3-wire connectors are available
- Wires with cross-sectional areas ranging from 0.5 to 2.5 mm<sup>2</sup> can be easily connected
- Connect single strand, multiple strand and thin multiple strand wires
- Save time for installers and equipment manufacturers
- Connect more powerful devices quickly

产品型号 Product model	孔数 Hole number	额定电压 Rated voltage	额定电流 Rated current	实心导线 Solid wire BV	多股导线 Multiple conductor BVR/RV	剥线长度 Strip length	材质 Material
E-101	2	250V	5A	0.5-2.5mm <sup>2</sup> 20-14AWG	0.5-2.5mm <sup>2</sup> 20-14AWG	10 mm / 0.39 inches	外壳 Shell: PA 导体 Electric conductor: 紫铜 Red copper 弹簧扣 Spring fastener: 301
E-112	3						
E-121	2						



# 导轨型系列 Rail type series



快速连接器 Quick wire connector



手柄颜色可定制  
Handle color can be customized

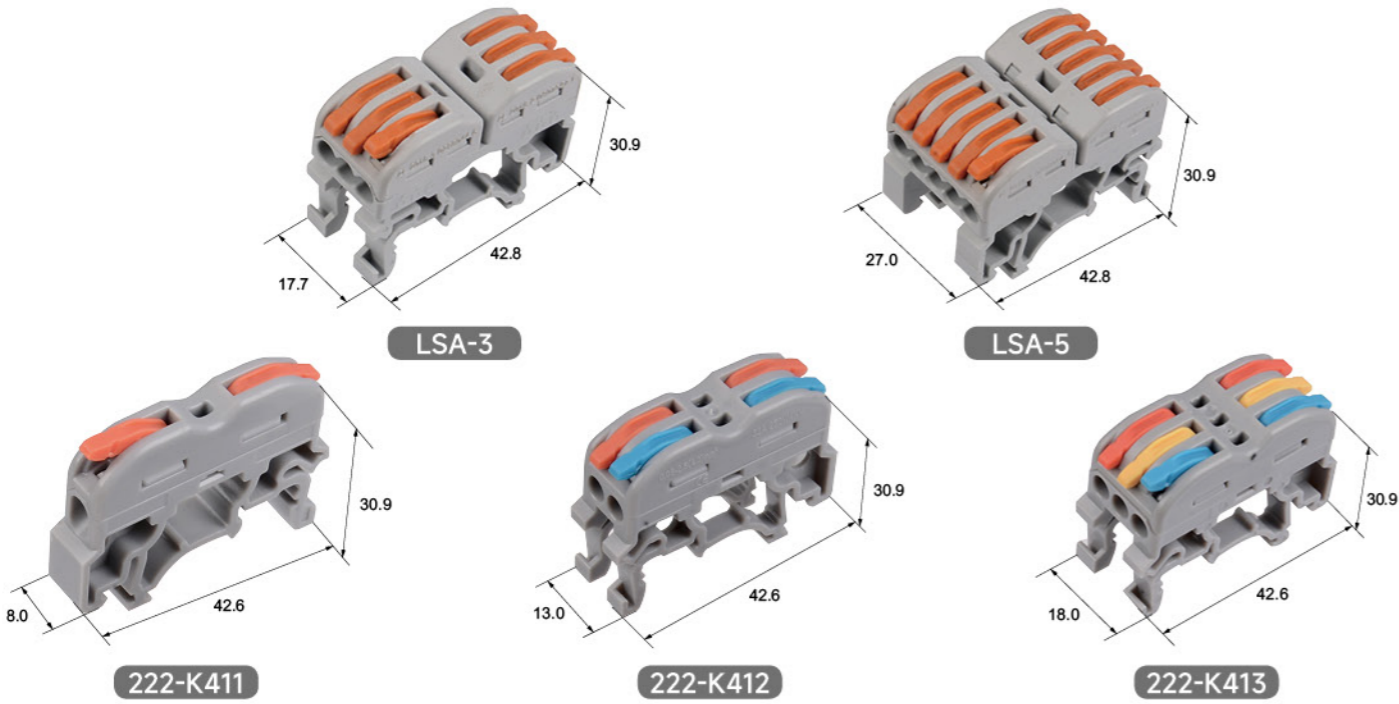

- 操作便捷 - 向上扳动操作手柄，插入导线，随后将手柄扳回原位
  - 导轨专用接线端子，可用来替代UK PT ST
  - 可提供2, 4, 6, 10线连接器
  - 可轻松连接截面积介于0.08-4.0mm<sup>2</sup>范围内的导线
  - 连接单股、多股绞合和细多股导线
  - 为安装人员和设备制造商节省时间
  - 可快速连接更大功率的设备
- Easy operation - Pull the handle up, insert the wire, and then pull the handle back in position
  - Rail special terminal, can be used to replace UK PT ST
  - Available with 2, 4, 6, and 10-wire connectors
  - Easily connect wires with cross-sectional areas ranging from 0.08 to 4.0 mm<sup>2</sup>
  - Connect single strand, multiple strand and thin multiple strand wires
  - Save time for installers and equipment manufacturers
  - Connect more powerful devices quickly

产品型号 Product model	孔数 Hole number	额定电压 Rated voltage	额定电流 Rated current	实心导线 Solid wire BV	多股导线 Multiple conductor BVR/RV	剥线长度 Strip length	材质 Material
222-K411	2	250V	32A	0.08-4.0mm <sup>2</sup> 28-14AWG	0.08-2.5mm <sup>2</sup> 28-14AWG	10 mm / 0.39 inches	外壳 Shell: PC 或 or PA 手柄 Handle: 或 or PA 导体 Electric conductor: 紫铜 Red copper 弹簧扣 Snap fastener: 301
222-K412	4						
222-K413	6						
LSA-3	6	20A					
LSA-5	10						



# 免破线系列 No break line series

# 37/38

快速连接器 Quick wire connector



手柄颜色可定制  
Handle color can be customized

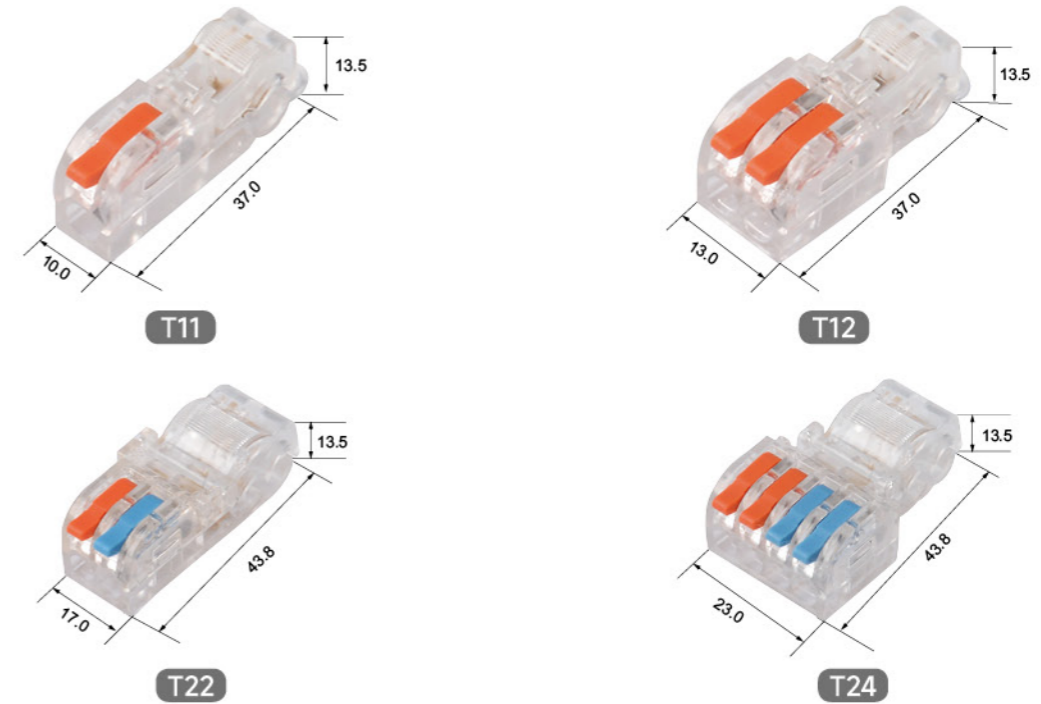

- 免断线分线器
  - 灯具专用接线端子
  - 可提供1分1/ 1分2
  - 可轻松连接截面积介于0.08-4.0mm<sup>2</sup>范围内的导线
  - 连接单股、多股绞合和细多股导线
  - 为安装人员和设备制造商节省时间
  - 可快速连接更大功率的设备
- Interrupt-free splitter
  - Lamps special terminal
  - 1 point 1/ 1 point 2 available
  - Easily connect wires with cross-sectional areas ranging from 0.08 to 4.0 mm<sup>2</sup>
  - Connect single strand, multiple strand and thin multiple strand wires
  - Save time for installers and equipment manufacturers
  - Connect more powerful devices quickly

产品型号 Product model	主线接线范围 Main line connection range	额定电压 Rated voltage	额定电流 Rated current	实心导线 Solid wire BV	多股导线 Multiple conductor BVR/RV	剥线长度 Strip length	材质 Material
T11		250V	32A	0.08-4.0mm <sup>2</sup> 28-12AWG	0.08-2.5mm <sup>2</sup> 28-12AWG	10 mm / 0.39 inches	外壳 Shell: PC 手柄 Handle: PA 导体 Electric conductor: 紫铜 Red copper 弹簧扣 Spring fastener: 301
T12	A型 type 0.5-1.5mm <sup>2</sup>						
T22	B型 type 1.5-2.5mm <sup>2</sup>						
T24	C型 type 2.5-4.0mm <sup>2</sup>						

